

# Grandstream Networks, Inc.

---

GRP2601(P) | GRP2602(P/W)

GRP2603(P) | GRP2604(P)

Essential IP Phones

## Administration Guide



**GRP2601/GRP2601P**



**GRP2602/GRP2602P/GRP2602W**



**GRP2603/GRP2603P**



**GRP2604/GRP2604P**



## **COPYRIGHT**

©2022 Grandstream Networks, Inc. <https://www.grandstream.com>

All rights reserved. Information in this document is subject to change without notice. Reproduction or transmittal of the entire or any part, in any form or by any means, electronic or print, for any purpose without the express written permission of Grandstream Networks, Inc. is not permitted.

The latest electronic version of this guide is available for download here:

<https://www.grandstream.com/support>

Grandstream is a registered trademark and Grandstream logo is trademark of Grandstream Networks, Inc. in the United States, Europe, and other countries.

## **CAUTION**

Changes or modifications to this product not expressly approved by Grandstream, or operation of this product in any way other than as detailed by this guide, could void your manufacturer warranty.

## **WARNING**

Please do not use a different power adaptor with devices as it may cause damage to the products and void the manufacturer warranty.



## U.S. FCC Part 68 Regulatory Information

This equipment complies with Part 68 of the FCC rules. Located on the equipment is a label that contains, among other information, the ACTA registration number and ringer equivalence number (REN). If requested, this information must be provided to the telephone company.

The REN is used to determine the quantity of devices which may be connected to the telephone line. Excessive REN's on the telephone line may result in the devices not ringing in response to an incoming call. In most, but not all areas, the sum of the REN's should not exceed five (5.0). To be certain of the number of devices that may be connected to the line, as determined by the total REN's contact the telephone company to determine the maximum REN for the calling area.

This equipment cannot be used on the telephone company-provided coin service. Connection to Party Line Service is subject to State Tariffs.

If this equipment causes harm to the telephone network, the telephone company will notify you in advance that temporary discontinuance of service may be required. If advance notice is not practical, the telephone company will notify the customer as soon as possible. Also, you will be advised of your right to file a complaint with the FCC if you believe it is necessary.

The telephone company may make changes in its facilities, equipment, operations, or procedures that could affect the operation of the equipment. If this happens, the telephone company will provide advance notice in order for you to make the necessary modifications in order to maintain uninterrupted service.

If any trouble is experienced with this equipment, please contact (Agent in the US):

**Company Name:** Grandstream Networks, Inc.

**Address:** 126 Brookline Ave, 3rd Floor Boston, MA 02215, USA

**Tel:** 1-617-5669300

**Fax:** 1-617-2491987

If the trouble is causing harm to the telephone network, the telephone company may request you to remove the equipment from the network until the problem is resolved.

This equipment uses the following USOC jacks: RJ45C.

It is recommended that the customer install an AC surge arrester in the AC outlet to which this device is connected. This is to avoid damaging the equipment caused by local lightning strikes and other electrical surges.

Since this device has the HAC function, the earpiece is easy to absorb small, please take care to avoid scratching.



## U.S. FCC Part 15 Regulatory Information

This device complies with part 15 of the FCC Rules. Operation is subject to the following two conditions:

(1) This device may not cause harmful interference, and (2) this device must accept any interference received, including interference that may cause undesired operation.

Any Changes or modifications not expressly approved by the party responsible for compliance could void the user's authority to operate the equipment.

**Note:** This equipment has been tested and found to comply with the limits for a Class B digital device, pursuant to part 15 of the FCC Rules. These limits are designed to provide reasonable protection against harmful interference in a residential installation. This equipment generates, uses, and can radiate radio

Frequency energy and, if not installed and used in accordance with the instructions, may cause harmful interference to radio communications. However, there is no guarantee that interference will not occur in a particular installation. If this equipment does cause harmful interference to radio or television reception, which can be determined by turning the equipment off and on, the user is encouraged to try to correct the interference by one or more of the following measures:

- Reorient or relocate the receiving antenna.
- Increase the separation between the equipment and receiver.
- Connect the equipment into an outlet on a circuit different from that to which the receiver is connected.
- Consult the dealer or an experienced radio/TV technician for help.

This equipment complies with FCC radiation exposure limits set forth for an uncontrolled environment. This equipment should be installed and operated with minimum distance 20cm between the radiator& your body. This transmitter must not be co-located or operating in conjunction with any other antenna or transmitter.



## Caution: Exposure to Radio Frequency Radiation

This equipment complies with EU radiation exposure limits set forth for an uncontrolled environment. This equipment should be installed and operated with minimum distance of 20 cm between the radiator and your body.

## CE Authentication



BE	BG	CZ	DK	DE	EE	IE	EL	LI
ES	FR	HR	IT	CY	LV	LT	LU	CH
HU	MT	NL	AT	PL	PT	RO	SI	TR
SK	FI	SE	NO	IS	UK	UK(NI)		

In the UK and EU member states, operation of 5150-5350 MHz is restricted to indoor use only.

Hereby, Grandstream Networks, Inc. declares that the radio equipment GRP2602W are in compliance with Directive 2014/53/EU.

The full text of the EU declaration of conformity is available at the following internet address:

<https://www.grandstream.com/support/resources/>

## GNU GPL INFORMATION

GRP260X firmware contains third-party software licensed under the GNU General Public License (GPL). Grandstream uses software under the specific terms of the GPL. Please see the GNU General Public License (GPL) for the exact terms and conditions of the license.

Grandstream GNU GPL related source code can be downloaded from Grandstream web site from:

[https://www.grandstream.com/sites/default/files/Resources/grp\\_gpl\\_color.tar.gz](https://www.grandstream.com/sites/default/files/Resources/grp_gpl_color.tar.gz)



# Table of Contents

<b>DOCUMENT PURPOSE .....</b>	<b>11</b>
<b>CHANGE LOG .....</b>	<b>12</b>
Firmware Version 1.0.3.42 .....	12
Firmware Version 1.0.3.31 .....	12
Firmware Version 1.0.3.18 .....	13
Firmware Version 1.0.1.57 .....	14
Firmware Version 1.0.1.50 .....	14
Firmware Version 1.0.1.41 .....	14
Firmware Version 1.0.1.36 .....	14
Firmware Version 1.0.1.18 .....	14
<b>WELCOME .....</b>	<b>15</b>
<b>PRODUCT OVERVIEW .....</b>	<b>16</b>
Feature Highlights .....	16
Technical Specifications .....	17
<b>GETTING STARTED.....</b>	<b>23</b>
Equipment Packaging.....	23
GRP260X Phone Setup.....	24
<i>Using the Phone Stand .....</i>	<i>24</i>
<i>Using the Slots for Wall Mounting.....</i>	<i>24</i>
Connecting the GRP260X .....	25
Configuration via Keypad .....	26
Configuration via Web Browser .....	32
Saving Configuration Changes.....	33
Rebooting from Remote Locations.....	33
<b>CONFIGURATION GUIDE.....</b>	<b>34</b>



Status Page Definitions .....	34
Account Page Definitions .....	37
Phone Settings Page Definitions .....	55
Network Settings Page Definitions .....	62
Programmable keys Page Definitions .....	67
System Settings Page Definitions .....	73
Maintenance Page Definitions .....	80
Application Page Definitions .....	88
External Service Page Definitions .....	92
<b>NAT SETTINGS .....</b>	<b>96</b>
<b>PACKET CAPTURE .....</b>	<b>97</b>
<b>UPGRADING AND PROVISIONING .....</b>	<b>98</b>
Unified Firmware .....	98
Firmware Upgrade .....	98
<i>Upgrade via Web GUI .....</i>	<i>99</i>
<i>No Local TFTP/FTP/HTTP Servers .....</i>	<i>99</i>
Custom Ringtones Provisioning .....	100
Phone Provisioning .....	100
<i>Configuration File Download .....</i>	<i>100</i>
<i>No Touch Provisioning .....</i>	<i>103</i>
<b>RESTORE FACTORY DEFAULT SETTINGS .....</b>	<b>104</b>
Restore Factory Settings using LCD menu .....	104
Restore to Factory Default via Web GUI .....	104
Restore to Factory Default via Keypad .....	104
<b>EXPERIENCING GRP260X .....</b>	<b>105</b>





## Table of Tables

Table 1: GRP260X Features in a Glance .....	16
Table 2: GRP2601/GRP2601P Technical Specifications .....	17
Table 3: GRP2602/GRP2602P/GRP2602W Technical Specifications .....	18
Table 4: GRP2603/GRP2603P Technical Specifications .....	19
Table 5: GRP2604/GRP2604P Technical Specifications .....	21
Table 6: Equipment Packaging .....	23
Table 7: Configuration Menu .....	26
Table 8: Status Page Definitions .....	34
Table 9: Account Page Definitions .....	37
Table 10: Settings Page Definitions .....	55
Table 11: Network Page Definitions .....	62
Table 12: Programmable Keys Page Definitions .....	67
Table 13: System Settings Page Definitions .....	73
Table 14: Maintenance Page Definitions.....	80
Table 15: Application Page Definitions.....	88
Table 16: External Service Page Definitions .....	92



## Table of Figures

Figure 1: GRP260X Package Content.....	23
Figure 2: Phone Stand and Mounting Slots on the GRP260X.....	24
Figure 3: Tab on the Handset Cradle .....	24
Figure 4: GRP260X Back Side View.....	26
Figure 5: GRP260x LCD settings.....	31
Figure 6: Packet Capture in Idle .....	97
Figure 7: Packet Capture when running .....	97
Figure 8: GRP260X Unified Firmware .....	98
Figure 9: Custom ringtone provisioning .....	100
Figure 10: Config File Download.....	101
Figure 11: Certificates Files Download .....	103



## DOCUMENT PURPOSE

This document describes how to configure GRP260X features via phone's LCD menu and Web GUI menu. The intended audiences of this document are phone administrators.

To learn the basic functions of GRP2601(P)/GRP2602(P/W), GRP2603(P) and GRP2604(P), please visit <https://www.grandstream.com/support> to download the latest "GRP260X User Guide".

This guide covers the following topics:

- [Product Overview](#)
- [Getting Started](#)
- [Configuration Guide](#)
- [NAT Settings](#)
- [Packet Capture](#)
- [Upgrading and Provisioning](#)
- [Restore Factory Default Settings](#)
- [Experiencing GRP260X](#)



## CHANGE LOG

This section documents significant changes from previous versions of user manuals for GRP260X. Only major new features or major document updates are listed here. Minor updates for corrections or editing are not documented here.

### Firmware Version 1.0.3.42

- Added Input language support for Arabic, Catalan, Nederland's, Svenska, Slovakian. [Technical Specifications]
- Added support of DNS & NAT Status display from Device's web UI. [Status Page Definitions]
- Added support to access the Wi-Fi network settings on the GRP2602W LCD when the device is in Constraint Mode. [Wi-Fi Settings Security Level]
- Added Ethernet, Wi-Fi, and VPN pages in LCD menu network status. [Table 7: Configuration Menu]
- Added support to configure UCM user SIP password [UCM User Password]
- Added Support for Greek letters input with keypad. . [Technical Specifications]
- Added support to disable mute key in call feature. [Enable Mute Key in Call]
- Added support of special feature option "Zoom". [Special Feature]
- Added support of TCP Keep-alive for the TCP connection between the terminal and the SIP server. [Enable TCP Keep-Alive]
- Added Support "Yerevan" to GMT +04:00 Time zone. [Time Zone]
- Added support to send extended DTMF [A, B, C, D] for transfer key. [In-Call Dial Number on Pressing Transfer Key]
- Added support of more detailed network port information. [Status Page Definitions]
- Improved Presence Watcher icon status to distinguish different phone status. [Programmable keys Page Definitions]
- Added support of RTCP keep-alive method. [RTCP Keep-Alive Method]
- Added support of RTP keep-alive method. [RTP Keep-Alive Method]
- Added Ability to customize keypad to lock when phone is idle or in call. [Keypad Lock Type]

### Firmware Version 1.0.3.31

- Added Ability to configure programmable keys via LCD [Allow Programmable Key Configuration via LCD]
- Added Support of rport (RFC 3581) [Support rport (RFC3581)]
- Added Ability to enable DND from web UI. [Enable DND Feature]
- Added Ability to remove password requirement during factory reset [FACTORY RESET SECURITY LEVEL]



- Added Support of multiple screens for custom idle screen XML file [XML FILE]
- Added Support of Selection “All for Selection” for Option “Transfer Mode via Programmable Keys” [Transfer Mode via Programmable Keys]
- Added key combination (Softkey1+Down) and call feature code (\*\*02030203\*\*) to do factory reset [Factory reset via keypad]

## **Firmware Version 1.0.3.18**

- Added Support of XML Application [XML Application]
- Added Support of Last Call Forward Always feature [Last Call Forward Always]
- Added Support of Show SIP Error Response feature [Show SIP Error Response]
- Added Support of Enable Hook Switch feature [Enable Hook Switch]
- Added Support of Contact Source Priority feature [Contact Source Priority]
- Added Support of Direct IP Call [Enable Direct IP Call]
- Added Support of Use Quick IP Call Mode [Use Quick IP Call Mode]
- Added Support of Predictive Dialing Feature [Predictive Dialing Feature]
- Added Support of Predictive Dialing Source [Predictive Dialing Source]
- Added Support of Onhook Dial Barging feature [On-hook Dial Barging]
- Added Support of Auto Redial feature [Enable Auto Redial]
- Added Support of Call Completion Service [Enable Call Completion Service]
- Added Support of Incoming Call Popup feature [Enable Incoming Call Popup]
- Added Support of Missed Call Notification feature [Enable Missed Call Notification]
- Added Support of Call Waiting Tone [Call Waiting Tone]
- Added Support of In-call DTMF Display [Enable In-Call DTMF Display]
- Added Support of Show on Hold Duration feature [Show On Hold Duration]
- Added Support of Auto Unmute feature [Enable Auto Unmute]
- Added Support of Busy Tone on Remote Disconnect feature [Enable busy tone remote disconnect]
- Added Support of enable or disable transfer function [Enable Transfer]
- Added Support of Attended Transfer Mode [Attended transfer mode]
- Added Support of Override DND feature [Override DND]
- Added Support of enable or disable conference function [Enable Conference]
- Added Support of Hold Call Before Adding Conferee feature. [Hold Call before Adding Conferee ]
- Added Support of Hidden Number Plan [Hidden Number Plan]



- Added Support of Warning tone [Enable warning Tone]
- Added Support of Group listening with handset/speaker [Group Listen with handset][Group Listen with Speaker]
- Added Support of multiple retries for the device to send requests to server. [Maximum Number of SIP Request Retries]
- Added Support of Failback Expiration time.

### **Firmware Version 1.0.1.57**

- Added System time zone display in web UI. [System Time-Zone]
- Added Support of [Recommend Time Zone]

### **Firmware Version 1.0.1.50**

- Added ability to Use Route Set in NOTIFY. [USE ROUTE SET IN NOTIFY]
- Added support for Auto Answer Numbers. [AUTO ANSWERNUMBERS]
- Added support for configuring the number to be dialed as DTMF using the TRANSFER button. [In-Call Dial Number on Pressing Transfer Key]
- Added Multicast Paging mode for MPKs on GRP2604/P. [MULTICAST PAGING MPK]
- Added ability to configure VPKs. [VPK]
- Added ability to use up to 3 XML Phonebook URLs. [Remote Phonebook]

### **Firmware Version 1.0.1.41**

- Added VLAN tag settings on device LCD menu. [Figure 5: GRP260x LCD settings]
- Added support for Line LED color scheme. [Line LED Color Scheme]
- Added support to force a reboot after provisioning by P-values. [P-value 22421]
- Added support to configure remaining accounts with a SIP account when public mode is enabled. [Allow Multiple Accounts]
- Added support of dial now option in the dial plan types. [Type]
- Added support to setup a Forward Always softkey on idle screen. [Custom Softkey Layout]
- Added support of "Ring for call waiting". [Ring for Call Waiting]

### **Firmware Version 1.0.1.36**

- Added Greek language support. [Multi-language]

### **Firmware Version 1.0.1.18**

- This is the initial version.



## WELCOME

Thank you for purchasing Grandstream GRP260X Essential IP Phones.

Part of the GRP series of Carrier-Grade IP Phones, the GRP2601/GRP2602 is an essential 2-line model designed with zero-touch provisioning for mass deployment and easy management. It features a sleek design and a suite of next-generation features including 5-way voice conferencing to maximize productivity and dual band Wi-Fi support (GRP2602W only), EHS support for Plantronics & Jabra & Sennheiser headsets and multi-language support. The GRP series includes carrier-grade security features to provide enterprise-level security, including secure boot, dual firmware images and encrypted data storage. For cloud provisioning and centralized management, the GRP260X is supported by Grandstream's Device Management System (GDMS), which provides a centralized interface to configure, provision, manage and monitor deployments of Grandstream endpoints. Built for the needs of desktop workers and designed for easy deployment by enterprises, service providers and other high-volume markets, the GRP2601/GRP2602 offers an easy-to-use and easy-to-deploy voice endpoint.

Part of the GRP series of Carrier-Grade IP Phones, the GRP2603/GRP2604 is an essential 3-line model designed with zero touch provisioning for mass deployment and easy management. It features a sleek design and a suite of next generation features including: 5-way voice conferencing to maximize productivity, full HD audio on both the speaker and handset to allow users to communicate with the utmost clarity, EHS support for Plantronics & Jabra & Sennheiser headsets and multi-language support. The GRP series includes carrier-grade security features to provide enterprise-level security, including secure boot, dual firmware images and encrypted data storage. For cloud provisioning and centralized management, the GRP2603/GRP2604 is supported by Grandstream's Device Management System (GDMS), which provides a centralized interface to configure, provision, manage and monitor deployments of Grandstream endpoints. Built for the needs of desktop workers and designed for easy deployment by enterprises, service providers and other high-volume markets, the GRP2603/GRP2604 offers an easy-to-use and easy-to-deploy voice endpoint.

The GRP260X series deliver superior HD audio quality, rich and leading-edge telephony features, protection for privacy, and broad interoperability with most 3<sup>rd</sup> party SIP devices and leading SIP/NGN/IMS platforms. GRP260X series is the perfect choice for enterprise users looking for a high quality, feature rich multi-line executive IP phone with advanced functionalities and performance.





## PRODUCT OVERVIEW

### Feature Highlights

The following table contains the major features of the GRP260X phones:

**Table 1: GRP260X Features in a Glance**

	<p><b>GRP2601</b> <b>GRP2601P</b></p>	<ul style="list-style-type: none"> <li>• 4 programmable context-sensitive soft keys.</li> <li>• 10/100M network ports.</li> <li>• Integrated PoE (for GRP2601P only).</li> <li>• 5-way conference.</li> <li>• Electronic Hook Switch (EHS) support for Plantronics &amp; Jabra &amp; Sennheiser.</li> </ul>
	<p><b>GRP2602</b> <b>GRP2602P</b> <b>GRP2602W</b></p>	<ul style="list-style-type: none"> <li>• 2 SIP account keys with dual-color LED</li> <li>• 4 programmable context-sensitive soft keys.</li> <li>• 10/100M network ports.</li> <li>• Integrated PoE (for GRP2602P only).</li> <li>• 5-way conference.</li> <li>• Electronic Hook Switch (EHS) support for Plantronics &amp; Jabra &amp; Sennheiser.</li> <li>• Wi-Fi support (GRP2602W only).</li> </ul>
	<p><b>GRP2603</b> <b>GRP2603P</b></p>	<ul style="list-style-type: none"> <li>• 3 SIP account keys with dual-color LED.</li> <li>• 4 XML programmable context sensitive soft keys</li> <li>• 132 x 64 backlit graphical LCD display</li> <li>• 10/100/1000 Mbps Ethernet ports.</li> <li>• Integrated PoE (GRP2603P only).</li> <li>• 5-way conference.</li> <li>• Electronic Hook Switch (EHS) support for Plantronics &amp; Jabra &amp; Sennheiser.</li> </ul>





**GRP2604**  
**GRP2604P**

- 3 SIP account keys with dual-color LED.
- 4 XML programmable context sensitive soft keys
- 132 x 64 backlit graphical LCD display
- 10/100/1000 Mbps Ethernet ports.
- Integrated PoE (GRP2604P only).
- 5-way conference.
- Electronic Hook Switch (EHS) support for Plantronics & Jabra & Sennheiser.

## Technical Specifications

The following table resumes all the technical specifications including the protocols / standards supported, voice codecs, telephony features, languages, and upgrade/provisioning settings for the GRP260X series.

**Table 2: GRP2601/GRP2601P Technical Specifications**

<b>Protocols/Standards</b>	SIP RFC3261, TCP/IP/UDP, RTP/RTCP, RTCP-XR, HTTP/HTTPS, ARP, ICMP, DNS(A record, SRV, NAPTR), DHCP, PPPoE, SSH, TFTP, NTP, STUN, SIMPLE, LLDP, LDAP, TR-069, SNMP, 802.1x, TLS, SRTP, IPV6
<b>Network Interfaces</b>	Dual switched auto-sensing 10/100/1000 Mbps Ethernet ports, integrated PoE (GRP2601P only)
<b>Graphic Display</b>	132 x 48 (2.21") LCD display
<b>Feature Keys</b>	4 XML programmable context sensitive soft keys, 5 (navigation, menu) keys. 8 dedicated function keys for: MESSAGE (with LED indicator), TRANSFER, HEADSET, MUTE, SEND/REDIAL, SPEAKERPHONE, VOL+, VOL
<b>Voice Codec</b>	Support for G.729A/B, G.711μ/a-law, G.726, G.722(wide-band),G723,iLBC, OPUS, in-band, and out-of-band DTMF(in audio, RFC2833, SIP INFO), VAD, AEC, CNG, PLC, AGC
<b>Auxiliary Ports</b>	RJ9 headset jack (allowing EHS with Plantronics & Jabra & Sennheiser headsets)
<b>Telephony Features</b>	Hold, transfer, forward, 3-way conference, call park, call pickup, downloadable phonebook (XML, LDAP, up to 2000 items), call waiting, call log (up to 800 records), off-hook auto dial, auto answer, click-to-dial, flexible dial plan, hot-desking, personalized music ringtones and music on hold, server redundancy and fail-over
<b>Base Stand</b>	Yes, 1 angle positions available
<b>Wall Mountable</b>	Yes, (*wall mount sold separately)
<b>QoS</b>	Layer 2 QoS (802.1Q, 802.1P) and Layer 3 (ToS, DiffServ, MPLS) QoS



<b>Security</b>	User and administrator level passwords, MD5 and MD5-sess based authentication, 256-bit AES encrypted configuration file, SRTP, TLS, 802.1x media access control, secure boot, WPA/WPA2 PSK/WPA3 support
<b>Multi-language</b>	English, Chinese, Korean, Japanese, German, Italian, French, Spanish, Portuguese, Russian, Croatian, Greek, Arabic, Catalan, Nederland's, Svenska, and Slovakian and more
<b>Upgrade/Provisioning</b>	Firmware upgrade via FTP/TFTP / HTTP / HTTPS, mass provisioning using GDMS/TR-069 or AES encrypted XML configuration file
<b>Power &amp; Green Energy Efficiency</b>	Universal Power Supply Input 100-240VAC 50-60Hz; Output +5VDC, 600mA; PoE: IEEE802.3af Class 1, 3.84W; IEEE802.3az (EEE) (GRP2601P Only)
<b>Physical</b>	Dimension: 208mm (L) x 180mm (W) x 63.4mm (H) (with handset) Unit weight:650g; Package weight:810g (860g for GRP2601)
<b>Temperature and Humidity</b>	Operation: 0°C to 40°C Storage: -10°C to 60°C Humidity: 10% to 90% Non-condensing
<b>Package Content</b>	GRP2601/2601P phone, handset with cord, base stand, universal power supply (GRP2601 only), network cable, Quick Installation Guide
<b>Compliance</b>	FCC: Part 15 Class B; FCC Part 68 HAC; CE: EN 55032; EN 55035; EN 61000-3-2; EN 61000-3-3; EN 62368-1; RCM: AS/NZS CISPR32; AS/NZS 62368.1; AS/CA S004; IC: ICES-003; CS-03;

**Table 3: GRP2602/GRP2602P/GRP2602W Technical Specifications**

<b>Protocols/Standards</b>	SIP RFC3261, TCP/IP/UDP, RTP/RTCP, RTCP-XR, HTTP/HTTPS, ARP, ICMP, DNS(A record, SRV, NAPTR), DHCP, PPPoE, SSH, TFTP, NTP, STUN, SIMPLE, LLDP, LDAP, TR-069, SNMP, 802.1x, TLS, SRTP, IPV6
<b>Network Interfaces</b>	Dual switched auto-sensing 10/100/1000 Mbps Ethernet ports, integrated PoE (GRP2602P only)
<b>Graphic Display</b>	132 x 48 (2.21") backlit graphical LCD display
<b>Wi-Fi</b>	Yes, Dual band support (GRP2602W only)
<b>Feature Keys</b>	2 SIP account keys with dual-color LED, 4 XML programmable context sensitive soft keys, 5 (navigation, menu) keys. 8 dedicated function keys for: MESSAGE (with LED indicator), TRANSFER, HEADSET, MUTE, SEND/REDIAL, SPEAKERPHONE, VOL+, VOL-
<b>Voice Codec</b>	Support for G7.29A/B, G.711μ/a-law, G.726, G.722(wide-band),G723,iLBC, OPUS, in-band, and out-of-band DTMF(in audio, RFC2833, SIP INFO), VAD,



	AEC, CNG, PLC, AGC
<b>Auxiliary Ports</b>	RJ9 headset jack (allowing EHS with Plantronics & Jabra & Sennheiser headsets)
<b>Telephony Features</b>	Hold, transfer, forward, 3-way conference, call park, call pickup, shared-call-appearance (SCA)/bridged-line-appearance (BLA), downloadable phonebook (XML, LDAP, up to 2000 items), call waiting, call log (up to 800 records), off-hook auto dial, auto answer, click-to-dial, flexible dial plan, hot-desking, personalized music ringtones and music on hold, server redundancy and fail-over
<b>HD audio</b>	Yes, HD handset and speakerphone with support for wideband audio
<b>Base Stand</b>	Yes, 1 angle positions available
<b>Wall Mountable</b>	Yes, (*wall mount sold separately)
<b>QoS</b>	Layer 2 QoS (802.1Q, 802.1p) and Layer 3 (ToS, DiffServ, MPLS) QoS
<b>Security</b>	User and administrator level passwords, MD5 and MD5-sess based authentication, 256-bit AES encrypted configuration file, SRTP, TLS, 802.1x media access control, secure boot
<b>Multi-language</b>	English, Chinese, Korean, Japanese, German, Italian, French, Spanish, Portuguese, Russian, Croatian, Greek, Arabic, Catalan, Nederland's, Svenska, and Slovakian and more
<b>Upgrade/Provisioning</b>	Firmware upgrade via FTP/TFTP / HTTP / HTTPS, mass provisioning using GDMS/TR-069 or AES encrypted XML configuration file
<b>Power &amp; Green Energy Efficiency</b>	Universal Power Supply Input 100-240VAC 50-60Hz; Output +5VDC, 600mA; PoE: IEEE802.3af Class 1, 3.84W; IEEE802.3az (EEE) (GRP2602P Only)
<b>Physical</b>	Dimension: 208mm (L) x 180mm (W) x 63.4mm (H) (with handset) Unit weight: 670g; Package weight: 830g (880g for GRP2602)
<b>Temperature and Humidity</b>	Operation: 0°C to 40°C Storage: -10°C to 60°C Humidity: 10% to 90% Non-condensing
<b>Package Content</b>	GRP2602 phone, handset with cord, base stand, universal power supply (GRP2602/GRP2602W only), network cable, Quick Installation Guide
<b>Compliance</b>	FCC: Part 15 Class B; FCC Part 68 HAC; CE: EN 55032; EN 55035; EN 61000-3-2; EN 61000-3-3; EN 62368-1; RCM: AS/NZS CISPR32; AS/NZS 62368.1; AS/CA S004; IC: ICES-003; CS-03;

**Table 4: GRP2603/GRP2603P Technical Specifications**

<b>Protocols/Standards</b>	SIP RFC3261, TCP/IP/UDP, RTP/RTCP, RTCP-XR, HTTP/HTTPS, ARP, ICMP, DNS(A record, SRV, NAPTR), DHCP, PPPoE, SSH, TFTP, NTP, STUN, SIMPLE, LLDP, LDAP, TR-069, SNMP, 802.1x, TLS, SRTP, IPV6
----------------------------	--



<b>Network Interfaces</b>	Dual switched auto-sensing 10/100/1000 Mbps Ethernet ports, integrated PoE (GRP2603P only)
<b>Graphic Display</b>	132 x 64 backlit graphical LCD display
<b>Feature Keys</b>	3 SIP account keys with dual-color LED, 4 XML programmable context sensitive soft keys, 5 (navigation, menu) keys. 9 dedicated function keys for: MESSAGE(with LED indicator), TRANSFER, HOLD, HEADSET, MUTE, SEND/REDIAL, SPEAKERPHONE, VOL+, VOL-
<b>Voice Codec</b>	Support for G7.29A/B, G.711µ/a-law, G.726, G.722(wide-band),G723,iLBC, OPUS, in-band, and out-of-band DTMF(in audio, RFC2833, SIP INFO), VAD, AEC, CNG, PLC, AGC
<b>Auxiliary Ports</b>	RJ9 headset jack (allowing EHS with Plantronics & Jabra & Sennheiser headsets)
<b>Telephony Features</b>	Hold, transfer, forward, 4-way conference, call park, call pickup, shared-call-appearance(SCA)/bridged-line-appearance(BLA), downloadable phonebook (XML, LDAP, up to 2000 items), call waiting, call log (up to 800 records), off-hook auto dial, auto answer, click-to-dial, flexible dial plan, hot-desking, personalized music ringtones and music on hold, server redundancy and fail-over
<b>HD audio</b>	Yes, HD handset and speakerphone with support for wideband audio
<b>Base Stand</b>	Yes, 2 angle positions available
<b>Wall Mountable</b>	Yes, (*wall mount sold separately)
<b>QoS</b>	Layer 2 QoS (802.1Q, 802.1p) and Layer 3 (ToS, DiffServ, MPLS) QoS
<b>Security</b>	User and administrator level passwords, MD5 and MD5-sess based authentication, 256-bit AES encrypted configuration file, SRTP, TLS, 802.1x media access control, secure boot, WPA/WPA2 PSK/WPA3 support.
<b>Multi-language</b>	English, Chinese, Korean, Japanese, German, Italian, French, Spanish, Portuguese, Russian, Croatian, Greek, Arabic, Catalan, Nederland's, Svenska, and Slovakian and more
<b>Upgrade/Provisioning</b>	Firmware upgrade via FTP/TFTP / HTTP / HTTPS, mass provisioning using GDMS/TR-069 or AES encrypted XML configuration file
<b>Power &amp; Green Energy Efficiency</b>	Universal Power Supply Input 100-240VAC 50-60Hz; Output +5VDC, 600mA;PoE: IEEE802.3af Class 1, 3.84W; IEEE802.3az (EEE) (GRP2603P Only)
<b>Physical</b>	Dimension: 214mm (L) x 206mm (W) x 68mm (H) (with handset) Unit weight: 780g; Package weight: 1090g for GRP2603P &1140g for GRP2603
<b>Temperature and Humidity</b>	Operation: 0°C to 40°C Storage: -10°C to 60°C Humidity: 10% to 90% Non-condensing
<b>Package Content</b>	GRP2603 phone, handset with cord, base stand, universal power supply



	(GRP2603 only), network cable, Quick Installation Guide
<b>Compliance</b>	FCC: Part 15 Class B; FCC Part 68 HAC; CE: EN 55032; EN 55035; EN 61000-3-2; EN 61000-3-3; EN 62368-1; RCM: AS/NZS CISPR32; AS/NZS 62368.1; AS/CA S004; IC: ICES-003; CS-03;

**Table 5: GRP2604/GRP2604P Technical Specifications**

<b>Protocols/Standards</b>	SIP RFC3261, TCP/IP/UDP, RTP/RTCP, RTCP-XR, HTTP/HTTPS, ARP, ICMP, DNS(A record, SRV, NAPTR), DHCP, PPPoE, SSH, TFTP, NTP, STUN, SIMPLE, LLDP, LDAP, TR-069, SNMP, 802.1x, TLS, SRTP, IPV6
<b>Network Interfaces</b>	Dual switched auto-sensing 10/100/1000 Mbps Ethernet ports, integrated PoE (GRP2603P only)
<b>Graphic Display</b>	132 x 64 backlit graphical LCD display
<b>Feature Keys</b>	3 SIP account keys with dual-color LED, 4 XML programmable context sensitive soft keys, 5 (navigation, menu) keys. 9 dedicated function keys for: MESSAGE(with LED indicator), TRANSFER, HOLD, HEADSET, MUTE, SEND/REDIAL, SPEAKERPHONE, VOL+, VOL-
<b>Voice Codec</b>	Support for G7.29A/B, G.711 $\mu$ /a-law, G.726, G.722(wide-band),G723,iLBC, OPUS, in-band, and out-of-band DTMF(in audio, RFC2833, SIP INFO), VAD, AEC, CNG, PLC, AGC
<b>Auxiliary Ports</b>	RJ9 headset jack (allowing EHS with Plantronics & Jabra & Sennheiser headsets)
<b>Telephony Features</b>	Hold, transfer, forward, 4-way conference, call park, call pickup, shared-call-appearance(SCA)/bridged-line-appearance(BLA), downloadable phonebook (XML, LDAP, up to 2000 items), call waiting, call log (up to 800 records), off-hook auto dial, auto answer, click-to-dial, flexible dial plan, hot-desking, personalized music ringtones and music on hold, server redundancy and fail-over
<b>HD audio</b>	Yes, HD handset and speakerphone with support for wideband audio
<b>Base Stand</b>	Yes, 2 angle positions available
<b>Wall Mountable</b>	Yes, (*wall mount sold separately)
<b>QoS</b>	Layer 2 QoS (802.1Q, 802.1p) and Layer 3 (ToS, DiffServ, MPLS) QoS
<b>Security</b>	User and administrator level passwords, MD5 and MD5-sess based authentication, 256-bit AES encrypted configuration file, SRTP, TLS, 802.1x media access control, secure boot, WPA/WPA2 PSK/WPA3 support.
<b>Multi-language</b>	English, German, Italian, French, Spanish, Portuguese, Russian, Croatian, Chinese, Korean, Japanese, Greek, Arabic, Catalan, Nederland's, Svenska, and Slovakian and more



<b>Upgrade/Provisioning</b>	Firmware upgrade via FTP/TFTP / HTTP / HTTPS, mass provisioning using GDMS/TR-069 or AES encrypted XML configuration file
<b>Power &amp; Green Energy Efficiency</b>	Universal Power Supply Input 100-240VAC 50-60Hz; Output +5VDC, 600mA;PoE: IEEE802.3af Class 2, 3.84W-6.49W; IEEE802.3az (EEE) (GRP2604P Only)
<b>Physical</b>	Dimension: 208mm (L) x 180mm (W) x 63.4mm (H) (with handset) Unit weight: 670g; Package weight:830g (880g for GRP2602)
<b>Temperature and Humidity</b>	Operation: 0°C to 40°C Storage: -10°C to 60°C Humidity: 10% to 90% Non-condensing
<b>Package Content</b>	GRP2604 phone, handset with cord, base stand, universal power supply (GRP2604 only), network cable, Quick Installation Guide
<b>Compliance</b>	FCC: Part 15 Class B; FCC Part 68 HAC; CE: EN 55032; EN 55035; EN 61000-3-2; EN 61000-3-3; EN 62368-1; RCM: AS/NZS CISPR32; AS/NZS 62368.1; AS/CA S004; IC: ICES-003; CS-03;



## GETTING STARTED

This chapter provides basic installation instructions including the list of the packaging contents and information for obtaining the best performance with the GRP260X phone.

### Equipment Packaging

**Table 6: Equipment Packaging**

GRP260X
<ul style="list-style-type: none"> <li>• 1 x GRP260X Main Case.</li> <li>• 1 x Handset.</li> <li>• 1 x Phone Stand.</li> <li>• 1 x Ethernet Cable.</li> <li>• 1 x Power Adapter (Except for GRP260xP).</li> <li>• 1 x Phone cord.</li> <li>• 1 x Quick Installation Guide.</li> </ul>

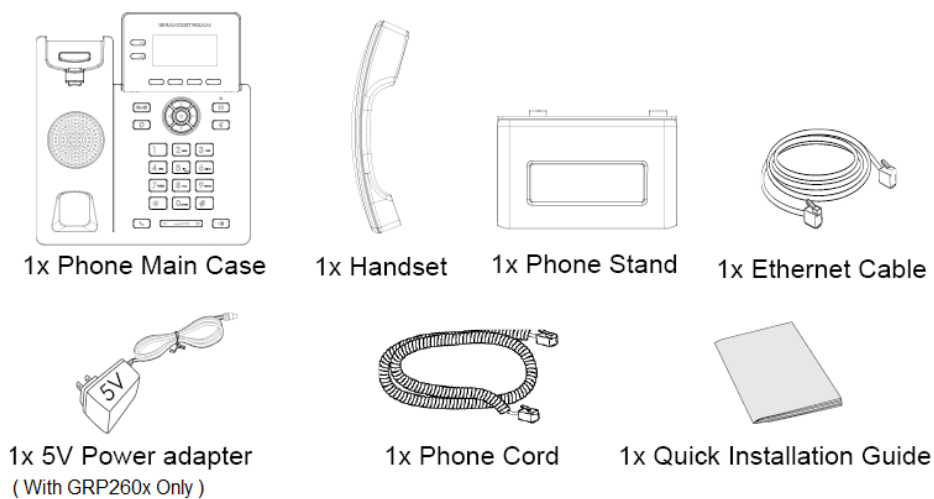

**Figure 1: GRP260X Package Content**

**Note:** Check the package before installation. If you find anything missing, contact your system administrator.



## GRP260X Phone Setup

The GRP260X phones can be installed on the desktop using the phone stand or attached on the wall using the slots for wall mounting.

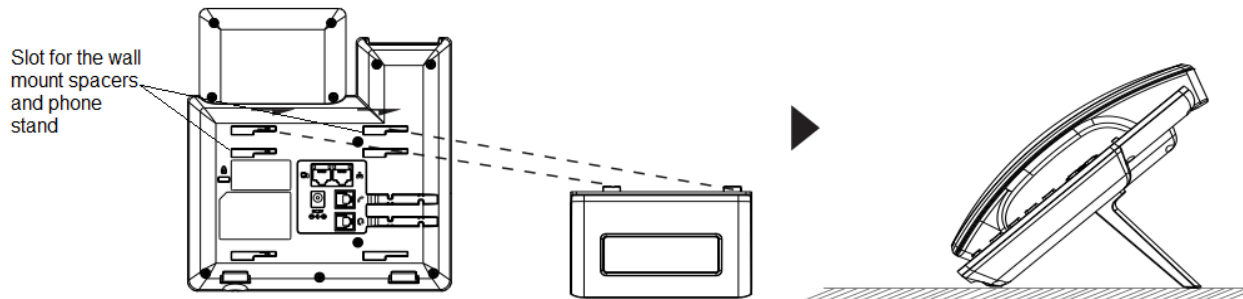

Figure 2: Phone Stand and Mounting Slots on the GRP260X

### Using the Phone Stand

For installing the phone on the table with the phone stand, attach the phone stand to the bottom of the phone where there is a slot for the phone stand. (Upper half, bottom part).

### Using the Slots for Wall Mounting

1. Attach the wall mount spacers to the slot for wall mount spacers on the back of the phone.
2. Attach the phone to the wall via the wall mount hole.
3. Pull out the tab from the handset cradle (See figure below).
4. Rotate the tab and plug it back into the slot with the extension up to hold the handset while the phone is mounted on the wall (See figure below).

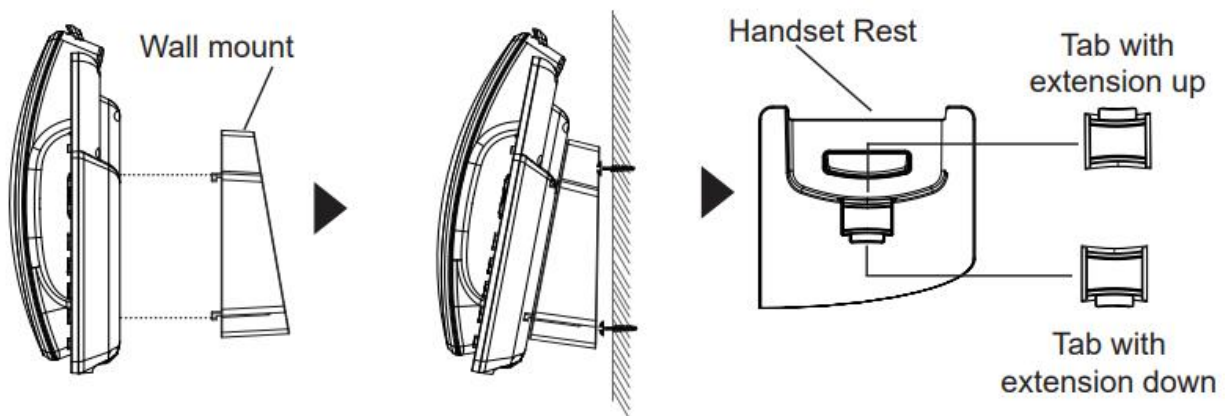

Figure 3: Tab on the Handset Cradle





## Connecting the GRP260X

To setup the GRP260X, follow the steps below:

1. Connect the handset and main phone case with the phone cord.
2. Connect the LAN port of the phone to the RJ-45 socket of a hub/switch or a router (LAN side of the router) using the Ethernet cable.
3. Connect the 5V DC output plug to the power jack on the phone; plug the power adapter into an electrical outlet. If PoE switch is used in step 3, this step could be skipped (For GRP260xP).
4. The LCD will display Grandstream logo. Before continuing, please wait for the date/time display to show up.
5. Using the phone embedded web server or keypad configuration menu, you can further configure the phone using either a static IP or DHCP.

### Using Wi-Fi (GRP2602W only):

- On LCD menu, navigate to “Settings → Wi-Fi settings” and enable Wi-Fi.
- Select “Wi-Fi Network” and GRP2602W will automatically start scanning within the range.
- A list of Wi-Fi networks will be displayed. Select the desired network, and if required, enter the correct password to connect.
- Users can add and connect to a hidden network by accessing “Wi-Fi” Network” and then press on Add softkey **+**. Then enter the Network’s information.

### Notes:

- When the GPR2602W is not connected to any network (including Ethernet and Wi-Fi), a prompt interface will pop up to notify users about it. Users can quickly enter “Wi-Fi Network” page by pressing on the Wi-Fi softkey.
- For easy deployment, The GRP2602W is out of the box is preconfigured to connect to a default SSID named **wp\_master** with a password (WPA/WPA2 PSK/WPA3) equal to **wp!987@admin**, users can adapt these settings from the web UI as well to make it easier for deployment on customer site.



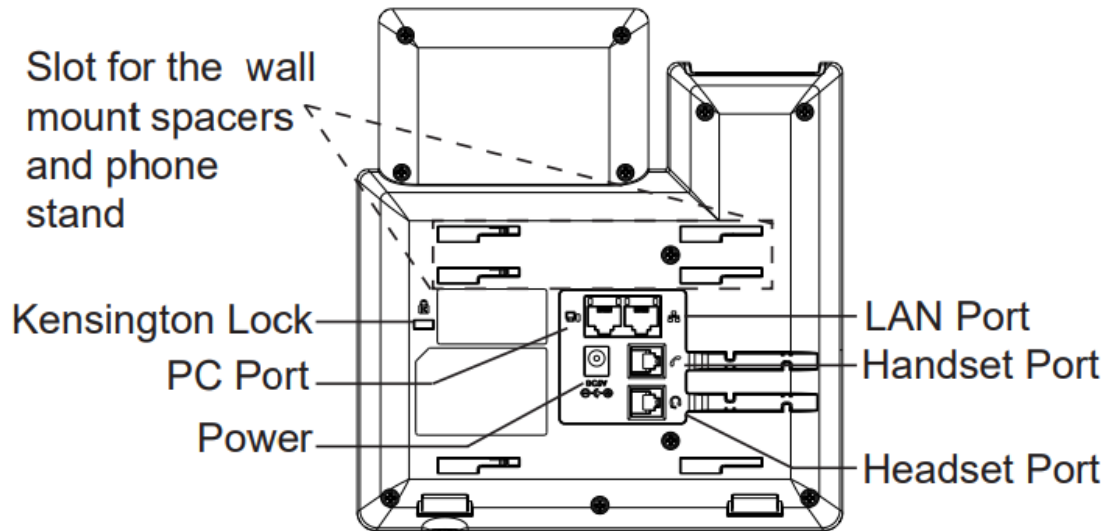



Figure 4: GRP260X Back Side View

## Configuration via Keypad

To configure the LCD menu using phone's keypad, follow the instructions below:

- **Enter MENU options.** When the phone is in idle, press the round MENU button or Menu Softkey  to enter the configuration menu.
- **Navigate in the menu options.** Press the arrow keys UP/DOWN keys to navigate in the menu options.
- **Enter/Confirm selection.** Press the round MENU to enter the selected option.
- **Exit.** Press Return Softkey  to exit to the previous menu.
- **Return to Home page.**

The MENU options are listed in the following table.

Table 7: Configuration Menu

<b>Status</b>	<p>Displays account status, network status, software version number and Hardware</p> <ul style="list-style-type: none"> <li>• <b>Warnings</b></li> </ul> <p>Press to display the received warnings. Press on a warning for more details.</p> <ul style="list-style-type: none"> <li>• <b>Network status.</b> <ul style="list-style-type: none"> <li>○ <b>Ethernet</b></li> </ul> </li> </ul> <p>Press to enter the sub menu for IP setting information (DHCP/Static IP/PPPoE), IPv4 address, IPv6 address, MAC address, Subnet Mask, Gateway and NTP</p>
---------------	--

servers.

- **DNS**

Press to check the configured DNS server.

- **Wi-Fi (GRP2602W only)**

Press to enter the sub menu for SSID information, WLAN MAC, IPv4 setting, IPv4 Address, Subnet Mask, IPv6 Address.

- **Account status.**

Shows Account registration status.

- **System Status**

Press to enter the sub menu for Hardware Information, Software version and IP Geographic Information.

Settings sub menu contains the following options:

- **Account Settings**

Enable/Disable SIP account, Configures Account Name, SIP server's address, SIP User ID, SIP Auth ID, SIP Password, Outbound Proxy, and Voice Mail Access Number.

- **Call Settings**

Enable/Disable **DND**, Enable/Disable **Auto Answer** for SIP account, Enable/Disable **Call Forward (Forward All/Busy/No Answer)**.

- **Basic Settings**

- **Sounds**

Configures account ringtone and adjusts volume settings by pressing left/right arrow key.

- **Appearance**

Configures **Active/Idle LCD Brightness** and **Active LCD Timeout**.

- **Date Time**

Adjusts Time and Date displaying format.

- **Time Zone**

Choose your Time Zone from the list by scrolling with UP/DOWN keys.

- **Language**

Selects the language to be displayed on the phone's LCD. Users could select Automatic for local language based on IP location if available. By default, it is Auto.



- **Keypad Lock**

Enables/Disables Keypad lock. Users can choose the Keypad Lock type (All Keys/Functional keys) and set up the lock password. If users enabled Keypad lock without configuring a password; They can unlock the phone by pressing on the unlock softkey.

- **Headset Type**

Choose the headset type of the headset connect to the phone. Users could choose Normal, Plantronics EHS, Jabra EHS, Sennheiser EHS.

- **Softkey bar Style**

Choose the softkey bar style (4 styles are available). Select the style using LEFT/RIGHT arrows.

- **Input Method**

Configures the **Default Input Method** (123, ABC, Abc, abc) for Contacts/LCD and the **Input Language**.

- **Key Customization**

- **Advanced settings**

- **Upgrade**

Check for upgrade by contacting the firmware upgrade server.

- **Syslog**

Configures Syslog level, Transport protocol and Syslog Server's address.

- **Security**

Enables disables Web and SSH access.

- **Alternative Firmware**

Press  softkey to switch between the dual firmware versions loaded to the phone. The phone will reboot with the chosen version.

- **Factory Reset:**

Perform Factory reset to the phone. All device configuration and user data will be lost after factory reset.

- **Ethernet Settings**

- **Internet Protocol**

Selects Prefer IPv4 / Prefer IPv6 / IPv4 only or IPv6 only. The default setting is "IPv4 only".

- **IPv4 Setting**



	<p>Selects IP mode (DHCP/Static IP/PPPoE); Configures PPPoE account ID and password; Configures static IP address, Netmask, Gateway, Preferred DNS server.</p> <ul style="list-style-type: none"> <li>○ <b>IPv6 Setting</b></li> </ul> <p>Selects IP mode (DHCP/Static IP); Configures static IP address, IPv6 Prefix (64 bits), IPv6 Preferred DNS server.</p> <ul style="list-style-type: none"> <li>○ <b>VLAN Setting</b></li> </ul> <p>Enables CDP/LLDP, Configures LLDP TX interval, Enables Manual VLAN Configuration, Configures Layer 2 QoS 802.1q (VLAN ID/Priority).</p> <ul style="list-style-type: none"> <li>● <b>Wi-Fi Settings (GRP2602W only)</b> <ul style="list-style-type: none"> <li>○ <b>Wi-Fi</b></li> </ul> <p>Enables/disables Wi-Fi;</p> <ul style="list-style-type: none"> <li>○ <b>Wi-Fi Band</b></li> </ul> <p>Choose Wi-Fi band (2G , 5G or 2G&amp;5G).</p> <ul style="list-style-type: none"> <li>○ <b>Wi-Fi Network</b></li> </ul> <p>Scans and displays available Wi-Fi networks.</p> </li> </ul>
<b>Messages</b>	<ul style="list-style-type: none"> <li>● <b>Instant Messages</b></li> </ul> <p>Displays received instant messages</p> <ul style="list-style-type: none"> <li>● <b>Voicemail</b></li> </ul> <p>Displays voicemail message information in the following format: Normal/Urgent</p>
<b>Call History</b>	<p>Displays Local Call Logs: “All” Calls / “Missed” Calls/ “Dialed” Calls/ “Answered” Calls.</p>
<b>Contacts</b>	<p><b>Contacts</b> sub menu includes the following options:</p> <ul style="list-style-type: none"> <li>● <b>Local Phonebook</b></li> <li>● <b>Local Group</b></li> <li>● <b>LDAP</b></li> </ul> <p>User could configure phonebooks/groups options here, download phonebook XML to the phone and search and dial from the local phonebook and search and dial from LDAP phonebook.</p>
<b>Factory Functions</b>	<p>Factory Functions sub menu includes the following options:</p> <ul style="list-style-type: none"> <li>● <b>Audio Loopback</b></li> </ul> <p>Speak to the phone using speaker/handset/headset. If you can hear your voice,</p>



	<p>your audio is working fine. Press Return Softkey to exit audio loopback mode.</p> <ul style="list-style-type: none"><li>• <b>Keypad/Led diagnosis</b></li></ul> <p>All LEDs will light up Press all the available keys on the phone. The LCD will display the name for the keys to be pressed to finish the keyboard diagnostic mode. Press Hook button to exit.</p> <ul style="list-style-type: none"><li>• <b>Certification Verification</b></li></ul> <p>Verify the certificate loaded on the phone.</p>
<b>Reboot</b>	Reboots the phone.

The following picture shows the keypad MENU configuration flow:



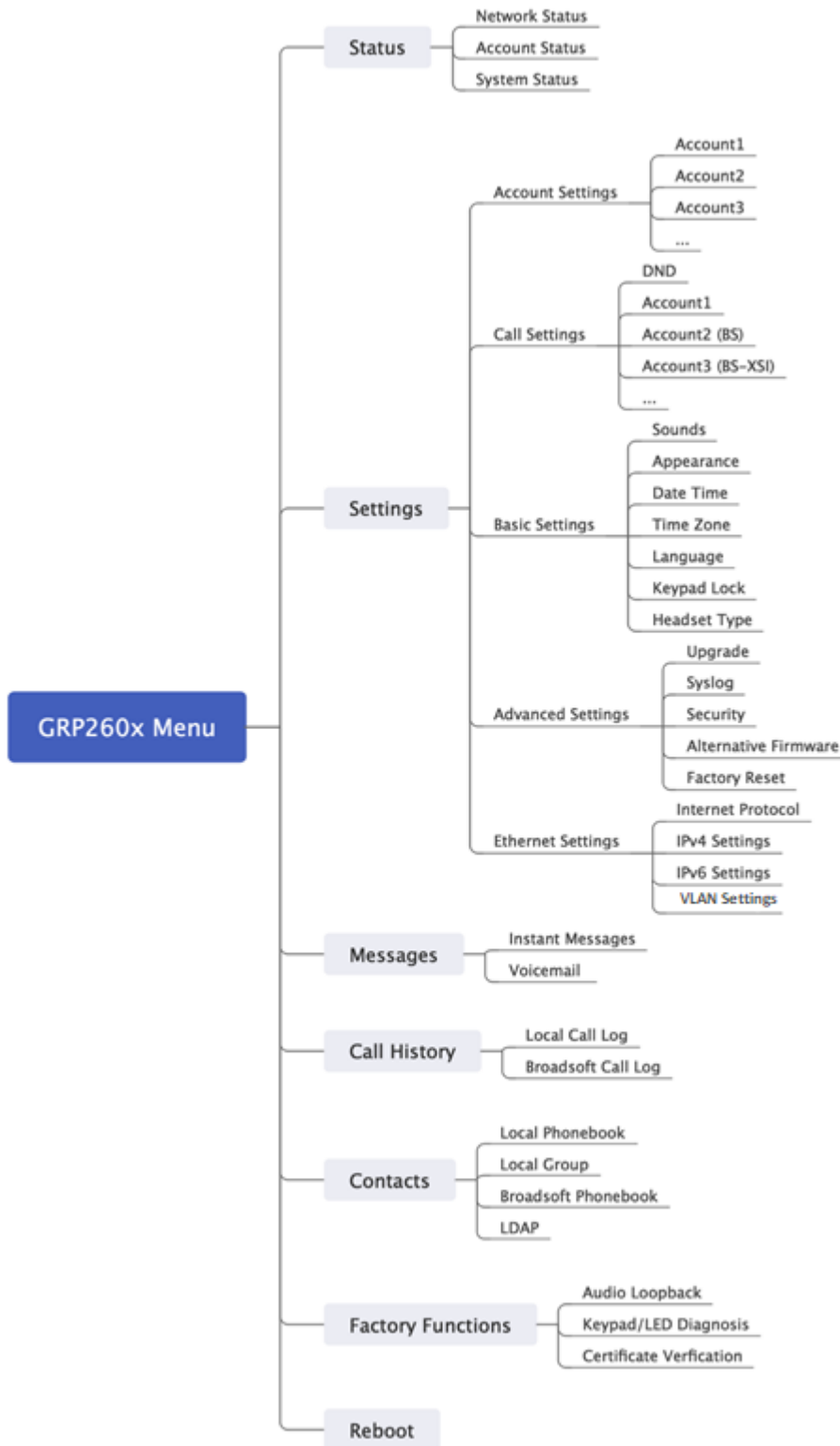

Figure 5: GRP260x LCD settings



## Configuration via Web Browser

The GRP260X embedded Web server responds to HTTP/HTTPS GET/POST requests. Embedded HTML pages allow a user to configure the IP phone through a Web browser such as Google Chrome, Mozilla Firefox, and Microsoft's IE. To access the Web GUI:

1. Connect the computer to the same network as the phone.
2. Make sure the phone is turned on and shows its IP address. You may check the IP address by pressing the Up-arrow button when phone is at idle state.
3. Open a Web browser on your computer.
4. Enter the phone's IP address in the address bar of the browser.
5. Enter the administrator's login and password to access the Web Configuration Menu.

### Notes:

- The computer must be connected to the same sub-network as the phone. This can be easily done by connecting the computer to the same hub or switch as the phone connected to. In absence of a hub/switch (or free ports on the hub/switch), please connect the computer directly to the PC port on the back of the phone.
- If the phone is properly connected to a working Internet connection, the IP address of the phone will display in MENU→Status→Network Status. This address has the format: xxx.xxx.xxx.xxx, where xxx stands for a number from 0-255. Users will need this number to access the Web GUI. For example, if the phone has IP address 192.168.40.154, please enter "http://192.168.40.154" in the address bar of the browser.
- There are two default passwords for the login page:

User Level	User	Password	Web Pages Allowed
End User Level	user	123	Only Status and Basic Settings
Administrator Level	admin	Random password available on the sticker at the back of the unit.	Browse all pages

- When changing any settings, always SUBMIT them by pressing the "Save" or "Save and Apply" button on the bottom of the page. If the change is saved only but not applied, after making all the changes, click on the "APPLY" button on top of the page to submit. After submitting the changes in all the Web GUI pages, reboot the phone to have the changes take effect if necessary (Most of the options do not require reboot).





## **Saving Configuration Changes**

After users makes changes to the configuration, press the "Save" button will save but not apply the changes until the "Apply" button on the top of web GUI page is clicked. Or users could directly press "Save and Apply" button.

## **Rebooting from Remote Locations**

Press the "Reboot" button on the top right corner of the web GUI page to reboot the phone remotely. The web browser will then display a reboot message. Wait for about 1 minute to log in again.



## CONFIGURATION GUIDE

This section describes the options in the phone's Web GUI. As mentioned, you can log in as an administrator or an end user.

- **Status:** Displays the Account status, Network status, and System Info of the phone.
- **Account:** To configure the SIP account.
- **Phone Settings:** To configure phone general settings, Call Settings, Ringtone, Multicast Paging.
- **Network Settings:** To configure network settings.
- **Programmable keys:** Configures idle and call screen softkeys, And the Multi-purpose keys settings for the GRP2604 only.
- **System Settings:** Configures Time and Language settings, Security Settings, Preferences, TR-069.
- **Maintenance:** To configure upgrading and provisioning, System Diagnostics, Outbound Notifications, Voice monitoring.
- **Application:** Configures Web Service settings, Contacts, LDAP , Call History.
- **External Service:** Configures GDS Settings, Call Center, BroadSoft XSI.

### Status Page Definitions

Table 8: Status Page Definitions

Status → Account Status	
<b>Account</b>	Account index. <ul style="list-style-type: none"> <li>• For GRP2601/GRP2601P: 2 SIP accounts</li> <li>• For GRP2602/GRP2602P/GRP2602W: 4 SIP accounts</li> <li>• For GRP2603/GRP2603P: 6 SIP accounts</li> <li>• For GRP2604/GRP2604P: 6 SIP accounts</li> </ul>
<b>SIP User ID</b>	Displays the configured SIP User ID for the account.
<b>SIP Server</b>	Displays the configured SIP Server address, URL or IP address, and port of the SIP server.
<b>SIP Registration</b>	Displays SIP registration status for the SIP account.
Status → Network Status	
Ethernet	
<b>LAN Port</b>	Displays the status and speed of the LAN port.
<b>PC Port</b>	Displays the status and speed of the PC port.
<b>MAC Address</b>	Global unique ID of device, in HEX format. The MAC address will be used



	for provisioning and can be found on the label coming with original box and on the label located on the back of the device.
<b>PPPoE Link Up</b>	Displays the status of PPPoE Link.
<b>IPv4</b>	
<b>IPv4 Address Type</b>	The configured address type: DHCP, Static IP or PPPoE.
<b>IPv4 Address</b>	The IPv4 address obtained on the phone.
<b>Gateway</b>	Displays the Gateway of the phone.
<b>IPv4 NAT Type</b>	Displays the IPv4 NAT Type.
<b>IPv6</b>	
<b>IPv6 Address Type</b>	Displays the IPv6 Address Type (Auto-configured or Statically configured).
<b>Global Unicast Address</b>	Displays the Global Unicast Address.
<b>Link-Local Address</b>	Displays the Link-Local Address.
<b>IPv6 Static Gateway</b>	Displays the IPv6 Static Gateway.
<b>IPv6 DUID</b>	Displays the IPv6 DUID (DHCP Unique Identifier) if Address Type is “Auto-configured”
<b>IPv6 NAT Type</b>	Displays the IPv6 NAT Type.
<b>Wi-Fi (GRP2602W only)</b>	
<b>WLAN MAC Address</b>	Displays the WLAN MAC Address.
<b>SSID</b>	Displays the SSID where the phone is connected via Wi-Fi.
<b>Country Code</b>	Displays the country code of the phone.
<b>IPv4</b>	
<b>IPv4 Address Type</b>	Displays the IPv4 Address Type (DHCP, Static or PPPoE)
<b>IPv4 Address</b>	Displays the actual IPv4 Address on the phone.
<b>Gateway</b>	Displays the Gateway of the phone.
<b>IPv4 NAT Type</b>	Displays the IPv4 NAT Type.
<b>IPv6</b>	
<b>IPv6 Address Type</b>	Displays the IPv6 Address Type (Auto-configured or Statically configured).
<b>Global Unicast Address</b>	Displays the Global Unicast Address.
<b>Link-Local Address</b>	Displays the Link-Local Address.
<b>IPv6 Static Gateway</b>	Displays the IPv6 Static Gateway.
<b>IPv6 DUID</b>	Displays the IPv6 DUID (DHCP Unique Identifier) if Address Type is “Auto-



	configured”
<b>IPv6 NAT Type</b>	Displays the IPv6 NAT Type.
<b>DNS &amp; NAT</b>	
<b>DNS Server</b>	Displays the DNS Server configured.
<b>DNS Mode</b>	Displays the DNS Mode used for each account.
<b>NAT Traversal</b>	Displays the NAT Traversal mode used for each account.
<b>Status → System Info</b>	
<b>Product Model</b>	Product model of the phone.
<b>Part Number</b>	Product part number.
<b>Software Version</b>	<ul style="list-style-type: none"> <li>• <b>Boot:</b> boot version number.</li> <li>• <b>Core:</b> core version number.</li> <li>• <b>Base:</b> base version number.</li> <li>• <b>Prog:</b> program version number. This is the main firmware release number, which is always used for identifying the software system of the phone.</li> <li>• <b>Locale:</b> locale version number.</li> </ul>
<b>IP Geographic Information</b>	<ul style="list-style-type: none"> <li>• <b>Language:</b> displaying language.</li> <li>• <b>Recommend Time Zone:</b> represent the time zone detected by IP address</li> </ul>
<b>System Up Time</b>	System up time since the last reboot.
<b>System Time</b>	Current system time on the phone system.
<b>System Time-Zone</b>	Displays the time zone that is configured by user
<b>Service Status</b>	GUI, Phone and CPE service status.
<b>System Information</b>	Download system information
<b>User Space</b>	Shows the percentage of the user space used and the status of the Database
<b>Core Dump</b>	Shows the status of the core dump and the core dump files generated if any. It also gives the ability to generate GUI/Phone core dump files manually.
<b>Special Feature</b>	<b>OpenVPN® Support:</b> displaying if the phone supports OpenVPN®.
<b>Status → Call status</b>	



<b>Call status</b>	Display the Call status on the phone with the related statistics. Note: The option "Display Report on Web UI" should be enabled
<b>Status → Call Feature status</b>	
<b>Accounts</b>	This Colum List the accounts available active and non-active
<b>DND</b>	This Colum shows the stat of the DND feature for each account
<b>Auto Answer</b>	This Colum shows the stat of the Auto Answer feature for each account
<b>Forward All</b>	This Colum shows the stat of the forward All feature for each account
<b>Busy Forward</b>	This Colum shows the stat of the Busy Forward feature for each account
<b>No Answer Forward</b>	This Colum shows the stat of the No answer Forward feature for each account

## Account Page Definitions

Table 9: Account Page Definitions

<b>Account x → General Settings</b>	
<b>Account Register</b>	
<b>Account Active</b>	Indicates whether the account is active. The default setting is "No".
<b>Account Name</b>	The name associated with each account to be displayed on the LCD. (e.g., MyCompany)
<b>SIP Server</b>	The URL or IP address, and port of the SIP server. This is provided by your VoIP service provider (e.g., sip.mycompany.com, or IP address)
<b>Secondary SIP Server</b>	The URL or IP address, and port of the SIP server. This will be used when the primary SIP server fails.
<b>Outbound Proxy</b>	IP address or Domain name of the Primary Outbound Proxy, Media Gateway, or Session Border Controller. If a symmetric NAT is detected, STUN will not work and ONLY an Outbound Proxy can provide a solution.



<b>Secondary Outbound Proxy</b>	Defines secondary outbound proxy that will be used when the primary proxy cannot be connected.
<b>SIP User ID</b>	User account information, provided by your VoIP service provider.
<b>SIP Authentication ID</b>	SIP service subscriber's Authenticate ID used for authentication. It can be identical to or different from the SIP User ID.
<b>SIP Authentication Password</b>	The account password required for the phone to authenticate with the SIP server before the account can be registered. After it is saved, this will appear as hidden for security purpose.
<b>Name</b>	The SIP server subscriber's name (optional) that will be used for Caller ID display (e.g., John Doe).
<b>TEL URI</b>	If the phone has an assigned PSTN telephone number, this field should be set to "user=phone". A "user=phone" parameter will be attached to the Request-URI and "To" header in the SIP request to indicate the E.164 number. If set to "Enable", "tel:" will be used instead of "sip:" in the SIP request.
<b>Voicemail Access Number</b>	Allows users to access voice messages by pressing the MESSAGE button on the phone. This value is usually the VM portal access number.
<b>BLF Server</b>	Configures the BLF server (optional) used for SUBSCRIBE requests.
<b>Account Display</b>	When set to "Username", the LCD will display the Username if it is not empty and when set to "User ID", the LCD will display the User ID if it is not empty.
<b>UCM User Password</b>	Enter the UCM password in order to log into the UCM user settings.
<b>Network Settings</b>	
<b>DNS Mode</b>	This parameter controls how the Search Appliance looks up IP addresses for hostnames. If "Use Configured IP" is selected, please fill in Primary IP, Backup IP 1 and Backup IP 2. <ul style="list-style-type: none"> <li>• A Record</li> <li>• SRV</li> <li>• NAPTR/SRV</li> <li>• Use Configured IP</li> </ul>
<b>Maximum Number of SIP Request Retries</b>	Sets the maximum number of retries for the device to send requests to the server. In DNS SRV configuration, if the destination address does not respond, all request messages are resent to the same address according to the configured retry times. Valid range: 1-10.
<b>DNS SRV Failover Mode</b>	Configures the preferred IP mode for DNS SRV. If set to "default", the first IP from the query result will be applied. If set to "Saved one until DNS TTL", previous IP will be applied before DNS timeout is reached. If set to "Saved



	<p>one until no response", previous IP will be applied even after DNS timeout until it cannot respond.</p> <ul style="list-style-type: none"> <li>• <b>Default</b></li> </ul> <p>If the option is set with "default", it will again try to send register messages to one IP at a time, and the process repeats.</p> <ul style="list-style-type: none"> <li>• <b>Saved one until DNS TTL</b></li> </ul> <p>If the option is set with "Saved one until DNS TTL", it will send register messages to the previously registered IP first. If no response, it will try to send one at a time for each IP. This behavior lasts if DNS TTL (time-to-live) is up.</p> <ul style="list-style-type: none"> <li>• <b>Saved one until no responses</b></li> </ul> <p>If the option is set with "Saved one until no responses", it will send register messages to the previously registered IP first, but this behavior will persist until the registered server does not respond.</p>
<b>Primary IP</b>	Configures the primary IP address where the phone sends DNS query to when "Use Configured IP" is selected for DNS mode.
<b>Backup IP 1</b>	Configures the backup IP 1 address where the phone sends DNS query to when "Use Configured IP" is selected for DNS mode.
<b>Backup IP 2</b>	Configures the backup IP 2 address where the phone sends DNS query to when "Use Configured IP" is selected for DNS mode.
<b>NAT Traversal</b>	<p>Configures whether NAT traversal mechanism is activated. Please refer to user manual for more details.</p> <p>If set to "STUN" and STUN server is configured, the phone will route according to the STUN server. If NAT type is Full Cone, Restricted Cone or Port-Restricted Cone, the phone will try to use public IP addresses and port number in all the SIP&amp;SDP messages.</p> <p>The phone will send empty SDP packet to the SIP server periodically to keep the NAT port open if it is configured to be "Keep-alive". Configure this to be "No" if an outbound proxy is used. "STUN" cannot be used if the detected NAT is symmetric NAT. Set this to "VPN" if OpenVPN is used.</p>
<b>Support rport (RFC3581)</b>	Configures to use symmetric response routing. If it is used, the "rport" field will be added to the Via header field in the SIP Request, and the information will be extracted from the SIP 200OK Response for SIP Register to rewrite the SIP Contact information and apply it in subsequent SIP Requests.
<b>Proxy-Require</b>	A SIP Extension to notify the SIP server that the phone is behind a NAT/Firewall.



<b>Use SBC</b>	Configures whether a SBC server is used. Note: If enabled, make sure an outbound proxy is set up.
<b>Account x → SIP Settings</b>	
<b>Basic Settings</b>	
<b>SIP Registration</b>	Selects whether the phone will send SIP Register messages to the proxy/server. The default setting is “Enabled”.
<b>UNREGISTER on Reboot</b>	<ul style="list-style-type: none"> <li>• If set to “<b>No</b>”, the phone will not unregister the SIP user's registration information before new registration.</li> <li>• If set to “<b>All</b>”, the SIP Contact header will use "*" to clear all SIP user's registration information.</li> <li>• If set to “<b>Instance</b>”, the phone only needs to clear the current SIP user's info.</li> </ul>
<b>REGISTER Expiration</b>	<p>Specifies the frequency (in minutes) in which the phone refreshes its registration with the specified registrar.</p> <p>The maximum value is 64800 minutes (about 45 days). The default value is 60 minutes.</p>
<b>SUBSCRIBE Expiration</b>	<p>Specifies the frequency (in minutes) in which the phone refreshes its subscription with the specified registrar.</p> <p>The maximum value is 64800 minutes (about 45 days). The default value is 60 minutes.</p>
<b>Re-Register before Expiration</b>	Specifies the time frequency (in seconds) that the phone sends re-registration request before the Register Expiration. The default value is 0.
<b>Registration Retry Wait Time</b>	Specifies the interval to retry registration if the process is failed. The valid range is 1 to 3600. The default value is 20 seconds.
<b>Add Auth Header on Initial REGISTER</b>	If enabled, the phone will add Authorization header in initial REGISTER request. Default is “Disabled”.
<b>Enable OPTIONS Keep Alive</b>	<p>Configures whether to enable SIP OPTIONS to track account registration status. If enabled, the phone will send periodic OPTIONS messages to server to track the connection status with the server.</p> <p>Default is “Disabled”.</p>
<b>OPTIONS Keep Alive Interval</b>	Configures the time interval the phone sends OPTIONS message to the server. If set to 30 seconds, it means the phone will send an OPTIONS message to the server every 30 seconds.
<b>OPTIONS Keep Alive Max Lost</b>	Configures the maximum number of times the phone will try to send OPTIONS message consistently to server without receiving a response. If





	set to "3", the phone will send OPTIONS message 3 times. If no response from the server, the phone will re-register.
<b>SUBSCRIBE for MWI</b>	When set to "Yes", a SUBSCRIBE for Message Waiting Indication will be sent periodically. The default setting is "No".
<b>SUBSCRIBE for Registration</b>	When set to "Yes", a SUBSCRIBE for Registration will be sent out periodically. The default setting is "No".
<b>Use Privacy Header</b>	Configures whether the "Privacy Header" is present in the SIP INVITE message. <ul style="list-style-type: none"> <li>• <b>Default:</b> the phone will add "Privacy Header" when special feature is not "Huawei IMS".</li> <li>• <b>Yes:</b> the phone will always add "Privacy Header".</li> <li>• <b>No:</b> the phone will not add "Privacy Header".</li> </ul> The default setting is "default".
<b>Use P-Preferred- Identity Header</b>	Configures whether the "P-Preferred-Identity Header" is present in the SIP INVITE message. <ul style="list-style-type: none"> <li>• <b>Default:</b> the phone will add "P-Preferred-Identity header" when special feature is not "Huawei IMS".</li> <li>• <b>Yes:</b> the phone will always add "P-Preferred-Identity header".</li> <li>• <b>No:</b> the phone will not add "P-Preferred-Identity header".</li> </ul>
<b>Use X-Grandstream-PBX Header</b>	Configures to use X-Grandstream-PBX header in SIP request. Default setting is "Yes".
<b>Use P-Access-Network-Info Header</b>	Configures to use P-Access-Network-Info header in SIP request. Default setting is "Yes".
<b>Use P-Emergency-Info Header</b>	Configures to use P-Emergency-Info header in SIP request. Default setting is "Yes".
<b>Use MAC Header</b>	<ul style="list-style-type: none"> <li>• If <b>Register Only</b>, all outgoing SIP message will include the MAC header.</li> <li>• If <b>Yes to all SIP</b>, all outgoing SIP messages will include the MAC header.</li> <li>• If <b>No</b>, the phone's MAC header will not be included in any outgoing SIP messages.</li> </ul>



	The default setting is “No”.
<b>Add MAC in User-Agent</b>	<p>If <b>Yes except REGISTER</b>, all outgoing SIP messages will include the phone's MAC address in the User-Agent header, except for REGISTER and UNREGISTER.</p> <p>If <b>Yes to All SIP</b>, all outgoing SIP messages will include the phone's MAC address in the User-Agent header.</p> <p>If <b>No</b>, the phone's MAC address will not be included in the User-Agent header in any outgoing SIP messages.</p> <p>The default setting is “No”.</p>
<b>SIP Transport</b>	<p>Select the network protocol used for the SIP transport.</p> <p>The default setting is “UDP”.</p>
<b>Enable TCP Keep-Alive</b>	Choose whether to enable TCP Keep-alive feature for the TCP connections between the SIP server and the endpoint
<b>SIP Listening Mode</b>	<p>Configure whether to listen to multiple SIP protocols.</p> <p>If set to “<b>Dual</b>”, phone will listen to TCP when UDP is selected.</p> <p>If set to “<b>Dual (Secured)</b>”, phone will listen to TLS/TCP when UDP is selected. If “TCP” or “TLS/TCP” is selected, UDP will be listened too.</p> <p>If set to “<b>Dual (BLF Enforced)</b>”, phone will try to enforce BLF subscriptions to use TCP protocol by adding 'transport=tcp' to the Contact header.</p> <p>The default setting is “Transport Only”.</p>
<b>Local SIP Port</b>	Configures the local SIP port used to listen and transmit.
<b>SIP URI Scheme when using TLS</b>	Specifies if “sip” or “sips” will be used when TLS/TCP is selected for SIP Transport. The default setting is “sips”.
<b>Use Actual Ephemeral Port in Contact with TCP/TLS</b>	<p>Configures whether the actual ephemeral port in contact with TCP/TLS will be used when TLS/TCP is selected for SIP Transport.</p> <p>The default setting is “No”.</p>
<b>Support SIP Instance ID</b>	<p>Configures whether SIP Instance ID is supported or not.</p> <p>The default setting is “Yes”.</p>
<b>SIP T1 Timeout</b>	SIP T1 Timeout is an estimate of the round-trip time of transactions between a client and server. If no response is received the timeout is increased and request re-transmit retries would continue until a maximum amount of time define by T2. The default setting is 0.5 seconds.
<b>SIP T2 Timeout</b>	SIP T2 Timeout is the maximum retransmit time of any SIP request messages (excluding the INVITE message). The re-transmitting and doubling of T1 continues until it reaches the T2 value. Default is 4 seconds.



<b>Outbound Proxy Mode</b>	<p>Configures whether to put the Outbound Proxy in the Route header, or if SIP messages should always be sent to Outbound Proxy.</p> <ul style="list-style-type: none"> <li>• <b>In route</b></li> <li>• <b>Not in route</b></li> <li>• <b>Always send to</b></li> </ul> <p>Default is "in route".</p>
<b>Enable 100rel</b>	<p>When enabled, the 100rel tag is appended to the value of the Supported header of the initial signaling messages.</p> <p>The default setting is "No".</p>
<b>Use Route Set in Notify (Follow RFC 6665)</b>	<p>Configures whether to use route set in NOTIFY (follow RFC 6665).</p> <ul style="list-style-type: none"> <li>• If enabled, the Request URI of the refresh subscription will use the URI in the received NOTIFY Contact (RFC 6665).</li> <li>• If disabled, the URI in the previously subscribed 200 OK Contact will be used.</li> </ul>
<b>Session Timer</b>	
<b>Enable Session Timer</b>	<p>Configures whether to enable session timer function. It enables SIP sessions to be periodically "refreshed" via a SIP request (UPDATE, or re-INVITE). If there is no refresh via an UPDATE or re-INVITE message, the session will be terminated once the session interval expires. If set to "Yes", the phone will use the related parameters when sending session timer according to "Session Expiration". If set to "No", session timer will be disabled.</p> <p>The default setting is "No".</p>
<b>Session Expiration</b>	<p>Session Expiration is the time (in seconds) where the session is considered timed out, provided no successful session refresh transaction occurs beforehand.</p> <p>The default setting is 180. The valid range is from 90 to 64800.</p>
<b>Min-SE</b>	<p>The minimum session expiration (in seconds). The default value is 90 seconds. The valid range is from 90 to 64800.</p>
<b>Caller Request Timer</b>	<p>If set to "Yes" and the remote party supports session timers, the phone will use a session timer when it makes outbound calls.</p> <p>The default setting is "No".</p>
<b>Callee Request Timer</b>	<p>If set to "Yes" and the remote party supports session timers, the phone will use a session timer when it receives inbound calls.</p> <p>The default setting is "No".</p>
<b>Force Timer</b>	<p>If set to "Yes", the phone will use the Session Timer even if the remote party</p>



	<p>does not support this feature. Otherwise, Session Timer is enabled only when the remote party supports it.</p> <p>The default setting is “No”.</p>
<b>UAC Specify Refresher</b>	<p>As a caller, select UAC to use the phone as the refresher, or select UAS to use the callee or proxy server as the refresher. When set to "Omit", the refresh object is not specified.</p> <p>The default setting is “UAC”.</p>
<b>UAS Specify Refresher</b>	<p>As a callee, select UAC to use caller or proxy server as the refresher, or select UAS to use the phone as the refresher.</p> <p>The default setting is “UAC”.</p>
<b>Force INVITE</b>	<p>Select "Yes" to force using the INVITE method to refresh the session timer.</p> <p>The default setting is “No”.</p>

### Account x → Codec Settings

#### Audio

<b>Preferred Vocoder (Choice 1 – 8)</b>	<p>Multiple vocoder types are supported on the phone, the vocoders in the list is a higher preference. Users can configure vocoders in a preference list that is included with the same preference order in SDP message.</p>
<b>Codec Negotiation Priority</b>	<p>Configures the phone to use which codec sequence to negotiate as the callee. When set to “Caller”, the phone negotiates by SDP codec sequence from received SIP Invite. When set to “Callee”, the phone negotiates by audio codec sequence on the phone. The default setting is “Callee”.</p>
<b>Use First Matching Vocoder in 200OK SDP</b>	<p>When set to "Yes", the device will use the first matching vocoder in the received 200OK SDP as the codec. The default setting is “No”.</p>
<b>iLBC Frame Size</b>	<p>Selects iLBC packet frame size. Users can choose from 20ms and 30ms.</p> <p>The default setting is “30ms”.</p>
<b>iLBC Payload Type</b>	<p>Specifies iLBC payload type. Valid range is 96 to 127. Cannot be the same as Opus or DTMF payload type. Valid range is 96 to 127. The default setting is “97”.</p>
<b>G.726-32 Packing Mode</b>	<p>Selects “ITU” or “IETF” for G726-32 packing mode.</p> <p>The default setting is “ITU”.</p>
<b>G.726-32 Dynamic Payload Type</b>	<p>Specifies G.726-32 payload type. Valid range is 96 to 127. Default is 127.</p>
<b>Opus Payload Type</b>	<p>Specifies Opus payload type. Valid range is 96 to 127. It cannot be the same as iLBC or DTMF Payload Type. Default value is 123.</p>
<b>Send DTMF</b>	<p>Specifies the mechanism to transmit DTMF digits. There are 3 supported modes:</p>



	<ul style="list-style-type: none"> <li>• <b>In audio:</b> DTMF is combined in the audio signal (not very reliable with low-bit-rate codecs).</li> <li>• <b>RFC2833</b> sends DTMF with RTP packet. Users can check the RTP packet to see the DTMFs sent as well as the number pressed.</li> <li>• <b>SIP INFO</b> uses SIP INFO to carry DTMF.</li> </ul> <p>Default setting is "RFC2833".</p>
<b>DTMF Payload Type</b>	Configures the payload type for DTMF using RFC2833. Cannot be the same as iLBC or OPUS payload type.
<b>Enable Audio RED with FEC</b>	If set to "Yes", FEC will be enabled for audio call. The default setting is "Yes".
<b>Audio FEC Payload Type</b>	Configures audio FEC payload type. The valid range is from 96 to 126. The default value is 121.
<b>Audio RED Payload Type</b>	Configures audio RED payload type. The valid range is from 96 to 126. The default value is 124.
<b>Silence Suppression</b>	If set to "Yes", when silence is detected, a small quantity of VAD packets (instead of audio packets) will be sent during the period of no talking. For codec G.723 and G.729 only. Default setting is "No"
<b>Jitter Buffer Type</b>	Selects either Fixed or Adaptive for jitter buffer type, based on network conditions. The default setting is "Adaptive".
<b>Jitter Buffer Length</b>	Selects jitter buffer length from 100ms to 800ms, based on network conditions. The default setting is "300ms".
<b>Voice Frames Per TX</b>	Configures the number of voice frames transmitted per packet. It is recommended that the IS limit value of Ethernet packet is 1500 bytes or 120 kbps. When configuring this, it should be noted that the "ptime" value for the SDP will change with different configurations here. This value is related to the codec used in the codec table or negotiate the payload type during the actual call. For example, if set to 2 and the first code is G.729, G.711 or G.726, the "ptime" value in the SDP datagram of the INVITE request is 20 ms. If the "Voice Frame/TX" setting exceeds the maximum allowed value, the phone will use and save the maximum allowed value for the selected first codec. It is recommended to use the default setting provided, and incorrect setting may affect voice quality.  The default setting is 2.
<b>G.723 Rate</b>	Selects encoding rate for G723 codec.
<b>RTP Settings</b>	



<b>SRTP Mode</b>	<p>Enable SRTP mode based on your selection from the drop-down menu.</p> <ul style="list-style-type: none"> <li>• <b>No</b></li> <li>• <b>Enabled but Not forced</b></li> <li>• <b>Enabled and Forced</b></li> <li>• <b>Optional</b></li> </ul> <p>The default setting is “No”.</p>
<b>SRTP Key Length</b>	<p>Allows users to specify the length of the SRTP calls. Available options are:</p> <ul style="list-style-type: none"> <li>• <b>AES 128&amp;256 bit</b></li> <li>• <b>AES 128 bit</b></li> <li>• <b>AES 256 bit</b></li> </ul> <p>Default setting is AES 128&amp;256 bit</p>
<b>Crypto Life Time</b>	<p>Enable or disable the crypto lifetime when using SRTP. If users set to disable this option, phone does not add the crypto lifetime to SRTP header. The default setting is “Yes”.</p>
<b>RTCP Mode</b>	<p>Configure RTCP port negotiations rules</p> <ul style="list-style-type: none"> <li>• <b>Default:</b> Use the traditional RTCP port, which is “RTP port+1.</li> <li>• <b>Negotiate RTCP Port:</b> Use attribute RTCP to negotiate.</li> <li>• <b>RTCP Mux:</b> The caller actively negotiates the RTCP port and indicates RTCP Mux at the same time.</li> <li>• <b>RTCP Mux Only:</b> The caller forces RTCP Mux, generated by the local media port only apply for RTP.</li> </ul>
<b>RTCP Keep-Alive Method</b>	<p>Configure the RTCP channel keep-alive packet type.</p> <ul style="list-style-type: none"> <li>• <b>Receiver Report:</b> The RTCP channel will send “receiver report+source description+RTCP extension” as keep alive data.</li> <li>• <b>Sender Report:</b> The RTCP channel will send “Sender report+source description+RTCP extension” as keep alive data.</li> </ul>
<b>RTP Keep-Alive Method</b>	<p>Configure the RTP channel keep-alive packet type.</p> <ul style="list-style-type: none"> <li>• <b>No:</b> No data will be sent.</li> <li>• <b>RTP version 1:</b> The wrong version infor “1” will be carried when sending RTP data packets.</li> </ul>
<b>VQ RTCP-XR Collector Name</b>	<p>Configure the host name of the central report collector that accepts voice quality reports contained in SIP PUBLISH messages.</p>
<b>VQ RTCP-XR Collector Address</b>	<p>Configure the IP address of the central report collector that accepts voice quality reports contained in SIP PUBLISH messages.</p>
<b>VQ RTCP-XR Collector Port</b>	<p>Configure the port of the central report collector that accepts voice quality reports contained in SIP PUBLISH messages.</p>



<b>Symmetric RTP</b>	Configures whether Symmetric RTP is used or not. Symmetric RTP means that the UA uses the same socket/port for sending and receiving the RTP stream. The default setting is "No".
<b>RTP Timeout (s)</b>	Configures the RTP timeout of the phone. If the phone does not receive the RTP packet within the specified RTP time, the call will be automatically disconnected. The default range is 0 and 6-600. If set to 0, the phone will not hang up the call automatically.
<b>Account x → Call Settings</b>	
<b>Call Features</b>	
<b>Auto Answer</b>	If set to "Yes", the phone will automatically turn on the speaker phone to answer incoming calls after a short reminding beep. Default setting is "No".
<b>Auto Answer Numbers</b>	Allows the user to configure specific numbers to auto answer. If not set, all numbers will be auto answered If auto answer is enabled. Up to 10 numbers can be configured.
<b>Custom Alert-Info for Auto Answer</b>	Used exclusively to match the contents of the Alert-Info header for auto answer. The default auto answer headers will not be matched if this is defined.
<b>Allow Auto Answer by Call-Info/Alert-Info</b>	If set to "Yes", the phone will automatically turn on the speaker phone to answer incoming calls after a short reminding beep, based on the SIP Call-Info/Alert-Info header sent from the server/proxy. Default is "Yes".
<b>Allow Barging by Call-Info/Alert-Info</b>	When enabled, the phone will automatically put the current call on hold and answer the incoming call based on the SIP Call-Info/Alert-Info header sent from the server/proxy. However, if the current call was answered based on the SIP Call-Info/Alert-Info header, then all other incoming calls with SIP Call-Info/Alert-Info headers will be rejected automatically. Default setting is "No".
<b>Send Anonymous</b>	If set to "Yes", the "From" header in outgoing INVITE messages will be set to anonymous. Default is "No".
<b>Anonymous Call Rejection</b>	If set to "Yes", anonymous calls will be rejected. The default setting is "No".
<b>Call Log</b>	Configures Call Log setting on the phone. <ul style="list-style-type: none"> <li>• <b>Log All Calls</b></li> <li>• <b>Log incoming/Outgoing Only (missed calls NOT recorded)</b></li> <li>• <b>Disable Call Log</b></li> </ul> The default setting is "Log All Calls".
<b>Transfer on Conference</b>	Configures whether the call is transferred to the other party if the conference





<b>Hangup</b>	<p>initiator hangs up.</p> <p>The default setting is "No".</p>
<b>Key as Send</b>	<p>Allows users to configure either the "*" or "#" keys as the "Send" key. Please make sure the dial plan is properly configured to allow dialing * and # out. The default setting is "Pound (#)".</p>
<b>Record Key Default Function</b>	<p>Configure whether to turn the recording function on or off when the "Record" key is pressed for the first time in a call under this account, and switch between the two. For example, the SIP server can be configured with the automatic start call recording function. In this case, Record key default function needs to be configured as "Record off".</p>
<b>Call Recording On</b>	<p>Configures the DTMF sequence sent when pressing the Record key during a call on this account. Toggles between this value and the off code if possible; otherwise always sends this code.</p>
<b>Call Recording Off</b>	<p>Configures the DTMF sequence sent when pressing the Recording key during a call on this account when turning recording off.</p>
<b>Enable Recovery on Blind Transfer</b>	<p>Enable recovery to the call to the transferee on failing blind transfer to the target. The default setting is "Yes".</p> <p><b>Notes:</b></p> <ol style="list-style-type: none"> <li>1) This feature only applies to blind transfer.</li> <li>2) This feature depends on how server handles transfer. If there is any NOTIFY from server, this feature will not take effect. If server responds 4xx, phone should try to recover regardless of this option.</li> <li>3) During blind transfer, after transferor received 200/202 for REFER, but there is no NOTIFY from server after 7 seconds, transferor will decide to recover the call with transferee or not depending on the options. This is the only case that this option will be applied.</li> </ol>
<b>Blind Transfer Wait Timeout</b>	<p>Configures the timeout (in seconds) when waiting for sipfrag response in blind transfer. Valid range is 30 to 300. Default setting is "30".</p>
<b>No Key Entry Timeout</b>	<p>Configures the timeout (in seconds) for no key entry. If no key is pressed after the timeout, the collected digits will be sent out. The default value is 4 seconds. The valid range is from 1 to 15.</p>
<b>Ring Timeout</b>	<p>Configures the timeout (in seconds) for the phone to ring when an incoming call is not answered. Valid range is 30 to 3600. The default setting is 60.</p>
<b>Refer-To Use Target Contact</b>	<p>If set to "Yes", the "Refer-To" header uses the transferred target's Contact header information for attended transfer.</p>
<b>RFC2543 Hold</b>	<p>Allows users to toggle between RFC2543 hold and RFC3261 hold. RFC2543</p>





	hold (0.0.0.0) allows user to disable the hold music sent to the other side. RFC3261 (a line) will play the hold music to the other side. The default setting is "No".
<b>Enable Call Waiting</b>	Configures the call waiting function for this account. If set to "Default", it will be configured according to global call waiting function. Default value is "Default".
<b>Dial plan</b>	
<b>Dial Plan Prefix</b>	Configures a prefix added to all numbers when making outbound calls.
<b>Bypass Dial Plan</b>	Bypass the dial plan when dialing from one of the available items: Contacts; Call History Incoming Call; Call History Outgoing Call ; Dialing Page ; MPK ; API
<b>Dial Plan</b>	<p>Configures the dial plan rule. For syntax and examples, please refer to user manual for more details.</p> <p>Dial Plan Rules:</p> <ol style="list-style-type: none"> <li>1. Accepted Digits: 1,2,3,4,5,6,7,8,9,0, *, #, A,a,B,b,C,c,D,d;</li> <li>2. Grammar: <b>x</b> – any digit from 0-9;</li> <li>3. Grammar: <b>X</b> – any character from 0-9, a-z, A-Z.       <ol style="list-style-type: none"> <li>a) <b>xx+</b> - at least 2 digit numbers</li> <li>b) <b>xx</b> – only 2 digit numbers</li> <li>c) <b>XX</b> – two characters ( AA, Ab, 1C, f5, 68,...)</li> <li>d) <b>!test</b> : only string "test" will pass the dial plan check</li> <li>e) <b>^</b> - exclude</li> <li>f) <b>[3-5]</b> – any digit of 3, 4, or 5</li> <li>g) <b>[147]</b> – any digit of 1, 4, or 7</li> <li>h) <b>&lt;2=011&gt;</b> - replace digit 2 with 011 when dialing</li> <li>i) <b> </b> - the OR operand</li> </ol> <ul style="list-style-type: none"> <li>• <u>Example 1</u>: {[369]11   1617xxxxxxx}</li> </ul> <p>Allow 311, 611, and 911 or any 11 digit numbers with leading digits 1617;</p> <ul style="list-style-type: none"> <li>• <u>Example 2</u>: {^1900x+   &lt;=1617&gt;xxxxxxx}</li> </ul> <p>Block any number of leading digits 1900 or add prefix 1617 for any dialed 7 digit numbers;</p> <ul style="list-style-type: none"> <li>• <u>Example 3</u>: {1xxx[2-9]xxxxxx   &lt;2=011&gt;x+}</li> </ul> <p>Allows any number with leading digit 1 followed by a 3-digit number, followed by any number between 2 and 9, followed by any 7-digit number OR Allows any length of numbers with leading digit 2, replacing the 2 with 011 when dialed.</p> <p><u>Example of a simple dial plan used in a Home/Office in the US:</u></p> </li></ol>



	<p>{ ^1900x.   &lt;=1617&gt;[2-9]xxxxxx   1[2-9]xx[2-9]xxxxxx   011[2-9]x.   [3469]11 }</p> <p>Explanation of example rule (reading from left to right):</p> <ul style="list-style-type: none"> <li>• ^1900x. – prevents dialing any number started with 1900;</li> <li>• &lt;=1617&gt;[2-9]xxxxxx – allows dialing to local area code (617) numbers by dialing 7 numbers and 1617 area code will be added automatically;</li> <li>• 1[2-9]xx[2-9]xxxxxx  - allows dialing to any US/Canada Number with 11 digits length;</li> <li>• 011[2-9]x – allows international calls starting with 011;</li> <li>• [3469]11 – allows dialing special and emergency numbers 311, 411, 611 and 911.</li> </ul> <p><b>Note:</b> In some cases, where the user wishes to dial strings such as *123 to activate voice mail or other applications provided by their service provider, the * should be predefined inside the dial plan feature. An example dial plan will be: { *x+ } which allows the user to dial * followed by any length of numbers. Max length of dial plan is up to 1024 characters.</p>
<b>Call Display</b>	
<b>Caller ID Display</b>	<p>When set to "Auto", the phone will look for the caller ID in the order of P-Asserted Identity Header, Remote-Party-ID Header and From Header in the incoming SIP INVITE. When set to "Disabled", all incoming calls are displayed with "Unavailable".</p>
<b>Callee ID Display</b>	<p>When set to "Auto", the phone will update the callee ID in the order of P-Asserted Identity Header, Remote-Party-ID Header and To Header in the 180 Ringing. When set to "Disabled", callee id will be displayed as "Unavailable". When set to "To Header", caller id will not be updated and displayed as To Header.</p>
<b>Ringtone</b>	
<b>Account Ring Tone</b>	<p>Allows users to configure the ringtone for the account. Users can choose from different ringtones from the dropdown menu.</p> <p><b>Note:</b> User can also choose silent ring tone.</p>
<b>Ignore Alert-Info header</b>	<p>Configures to play default ringtone by ignoring Alert-Info header. The default setting is "No".</p>
<b>Match Incoming Caller ID</b>	<p>Specifies matching rules with number, pattern, or Alert Info text (up to 10 matching rules). When the incoming caller ID or Alert Info matches the rule, the phone will ring with selected distinctive ringtone. Matching rules:</p> <ul style="list-style-type: none"> <li>• <u>Specific caller ID number</u>. For example, 8321123.</li> <li>• <u>A defined pattern</u> with certain length using <b>x</b> and <b>+</b> to specify, where x</li> </ul>



	<p>could be any digit from 0 to 9. Samples:</p> <p><b>xx+</b> : at least 2-digit number.</p> <p><b>xx</b> : only 2-digit number.</p> <p><b>[345]xx</b>: 3-digit number with the leading digit of 3, 4 or 5.</p> <p><b>[6-9]xx</b>: 3-digit number with the leading digit from 6 to 9.</p> <ul style="list-style-type: none"> <li>• <u>Alert Info text</u></li> </ul> <p>Users could configure the matching rule as certain text (e.g., priority) and select the custom ring tone mapped to it. The custom ring tone will be used if the phone receives SIP INVITE with Alert-Info header in the following format: <i>Alert-Info: &lt;http://127.0.0.1&gt;; info=priority</i></p> <p>Selects the distinctive ring tone for the matching rule. When the incoming caller ID or Alert Info matches one of the 10 rules, the phone will ring with the associated ringtone.</p>
--	---

**Account x → Advanced Settings**

**Security Settings**

<b>Check Domain Certificates</b>	Configures whether the domain certificates will be checked when TLS/TCP is used for SIP Transport. The default setting is “No”.
<b>Validate Certificate Chain</b>	Validate certification chain when TCP/TLS is configured. The default setting is “No”.
<b>Validate Incoming SIP Messages</b>	Specifies if the phone will check the incoming SIP messages Caller ID and CSeq headers. If the message does not include the headers, it will be rejected. The default setting is “No”.
<b>Omit charset=UTF-8 in MESSAGE</b>	Omit charset=UTF-8 in MESSAGE content-type
<b>Allow Unsolicited REFER</b>	Configures whether to dial the number carried by Refer-to header after receiving out-of-dialog SIP REFER request actively. If set to " <b>Disabled</b> ", the phone will send error warning and stop dialing. If set to " <b>Enabled/Force Auth</b> ", the phone will dial the number after sending authentication. If the authentication fails, it will stop dialing. If set to " <b>Enabled</b> ", the phone will dial all numbers carried by SIP REFER.
<b>Accept Incoming SIP from Proxy Only</b>	When set to “Yes”, the SIP address of the Request URL in the incoming SIP message will be checked. If it does not match the SIP server address of the account, the call will be rejected. The default setting is “No”.
<b>Check SIP User ID for Incoming INVITE</b>	If set to “Yes”, SIP User ID will be checked in the Request URI of the incoming INVITE. If it does not match the phone’s SIP User ID, the call will be rejected. The default setting is “No”.



<b>Allow SIP Reset</b>	Allow SIP Notification message to perform factory reset. The default setting is “No”.
<b>Authenticate Incoming INVITE</b>	If set to “Yes”, the phone will challenge the incoming INVITE for authentication with SIP 401 Unauthorized response. The default setting is “No”.
<b>MOH</b>	
<b>On Hold Reminder Tone</b>	Configures to play reminder tone when the call is on hold.
<b>Music On Hold URI</b>	Music On Hold URI to call when a call is on hold if server supports it.
<b>Advanced Features</b>	
<b>Special Feature</b>	Different soft switch vendors have special requirements. Therefore, users may need select special features to meet these requirements. Users can choose from Standard, Nortel MCS, Broadsoft, CBCOM, RNK, Sylanro, Huawei IMS, PhonePower, UCM Call center or Zoom depending on the server type. The default setting is “Standard”.
<b>Feature Key Synchronization</b>	This feature is used for Broadsoft call feature synchronization. When it is enabled, DND, Call Forward features and Call Center Agent status can be synchronized between Broadsoft server and phone. Default is “Disabled”.
<b>Conference URI</b>	Configures the conference URI when using Broadsoft N-way calling feature.
<b>Broadsoft Call Center</b>	When set to “Yes”, a Softkey “BSCCenter” is displayed on LCD. User can access different Broadsoft Call Center agent features via this Softkey. Please note that “Feature Key Synchronization” will be enabled regardless of this setting. Default setting is “No”. <b>Note:</b> To activate this feature, users need to change the special feature to Broadsoft and setup the Broadsoft Call Center to take effect.
<b>Hoteling Event</b>	Broadsoft Hoteling event feature. Default setting is “No”. With “Hoteling Event” enabled, user can access the Hoteling feature.
<b>Call Center Status</b>	When set to “Yes”, the phone will send SUBSCRIBE to the server to obtain call center status. The default setting is “No”.
<b>Broadsoft Executive Assistant</b>	When enabled, Feature Key Synchronization will be enabled regardless of web settings.
<b>Broadsoft Call Park</b>	When enabled, it will send SUBSCRIBE to Broadsoft server to obtain Call Park notifications. The default setting is “Disabled”.
<b>BLF (Busy Lamp Field) - GRP2604 only</b>	
<b>Presence Eventlist URI</b>	Configures Presence Eventlist URI to monitor the extensions on Multi-Purpose Keys.
<b>Eventlist BLF URI</b>	Configures Eventlist BLF URI to monitor the extensions on Multi-Purpose



	Keys
<b>Auto provision Eventlist</b>	Select the type of Eventlist to get automatically provisioned onto available MPKs. Whether its BLF Eventlist or Presence Eventlist.
<b>BLF Call-pickup</b>	<p>Configures BLF Call-pickup method:</p> <ul style="list-style-type: none"> <li>• <b>Auto:</b> The phone will do either Prefix or barge in code for BLF pickup depend on which on is set.</li> <li>• <b>Force BLF Call-pickup by prefix:</b> The phone will only use Prefix as BLF pickup method.</li> <li>• <b>Disabled:</b> The phone will ignore both BLF pickup method, now the monitored VPK will only dial the extension if pressed</li> </ul>
<b>BLF Call-pickup Prefix</b>	Configures the prefix prepended to the BLF extension when the phone picks up a call with BLF key. The default setting is **.
<b>Call Pickup Barge-In Code</b>	Configures feature access code of Call Pickup with Barge-in feature.
<b>PUBLISH for Presence</b>	<p>Enables presence feature on the phone.</p> <p>The default setting is "No".</p>
<b>SCA</b>	
<b>Enable SCA (Shared Call Appearance)</b>	If set to "Yes", the Shared Call Appearance (BroadSoft Standard) will be used for the registered account.
<b>Line-Seize Timeout</b>	Configures the interval (in seconds) when the line-seize is considered timed out when Shared Call Appearance feature is used. Valid range is 15 to 60.
<b>Account x → Dial Plan</b>	
<b>Name</b>	Enter the name for the configured rules.
<b>Rule</b>	Enter the rule settings (number pattern, prefix to add ...etc.).
<b>Type</b>	<p>Choose the type of the rule:</p> <ul style="list-style-type: none"> <li>• <b>Pattern:</b> The phone will dial the number matching the entered pattern.</li> <li>• <b>Block:</b> The phone will block the number/pattern matching the rule.</li> <li>• <b>Dial now:</b> The phone will dial immediately the number once the DTMF matches the dial plan.</li> <li>• <b>Prefix:</b> Specify the "Replaced" field to replace by the "Used" field to dial.</li> <li>• <b>Second tone:</b> The phone plays the second dial tone when the entered "Trigger" digit is dialed.</li> </ul>



## Account x → Hidden Number Plan

<b>Hidden Number Feature</b>	If set to "Yes", incoming and outgoing number display will be handled according to hidden number plan.
<b>Hidden Number Plan List</b>	<p>Currently, incoming and outgoing number display will be handled according to hidden number plan. Users are able to configure the hidden number rules, matching their syntax rules from top to bottom as follows:</p> <ol style="list-style-type: none"> <li>1. Expression      element(element)element      (element)element  element(element) (element)</li> <li>2. Element Rules • x: any digit number from 0-9 • +: any length after x(&gt;=1)  • \[-+...] or *: Escape symbol • (): The part that needs to be hidden, there can only be one hidden part in a rule</li> <li>3.Examples x+(xxxx)xxxx: 13705806547 -&gt; 137****6547 xxx(x+)xxxx:  07113705806547 -&gt; 071*****6547 071\ -x+(xxxx)xxxx: 071-13705806547  -&gt; 071-137****6547</li> </ol>
<b>Hidden Number Plan Test</b>	Enter the number to test the hidden rules of the current page. After confirming, please save and apply it.

## Hidden Number Plan

<b>Enable Local Call Features</b>	<p>When enabled, Do Not Disturb, Call Forwarding and other call features can be used via the local feature codes on the phone. Otherwise, the provisioned feature codes from the server will be used. User configured feature codes will be used only if server provisioned feature codes are not provided.</p> <p><b>Note:</b> If the device is registered with Broadsoft account, it does not matter if local call features are enabled or disabled, once the Broadsoft account is set, special feature to Broadsoft and Feature Key Synchronization is enabled, the call feature will be handled by Broadsoft server, not by the phone.</p>
-----------------------------------	--

## DND

<b>DND Call Feature On</b>	Configures DND feature code to turn on DND.
<b>DND Call Feature Off</b>	Configures DND feature code to turn off DND.

## Call Forward Always

<b>On</b>	Configures Call Forward Always feature code to activate unconditional call forwarding.
<b>Off</b>	Configures Call Forward Always feature code to deactivate unconditional call forwarding.
<b>Target</b>	The extension the call will be forwarded to.

Call Forward No Answer	
On	Configures Call Forward No Answer feature code to activate no answer call forwarding.
Off	Configures Call Forward No Answer feature code to deactivate no answer call forwarding.
Target	The extension the call will be forwarded to.
Call Forward No Answer Timeout (s)	Defines the timeout (in seconds) before the call is forwarded on no answer. valid range is 1 to 120.
Accounts → Account Swap	
Swap Account Settings	Allows users to swap the two accounts that they have configured. This will increase the flexibility of account management. <b>Note:</b> Make sure to press “Start” to complete the process.

## Phone Settings Page Definitions

Table 10: Settings Page Definitions

Phone Settings → General settings	
Basic Settings	
Local RTP Port	This parameter defines the local RTP port used to listen and transmit. It is the base RTP port for channel 0. When configured, channel 0 will use this port _value for RTP; channel 1 will use port_value+2 for RTP. Local RTP port ranges from 1024 to 65400 and must be even. Default value is 5004.
Local RTP Port Range	Gives users the ability to define the parameter of the local RTP port used to listen and transmit. This parameter defines the local RTP port from 48 to 10000. This range will be adjusted if local RTP port + local RTP port range is greater than 65486. Default setting is 200.
Use Random Port	When set to “Yes”, this parameter will force random generation of both the local SIP and RTP ports. This is usually necessary when multiple phones are behind the same full cone NAT. The default setting is “No” <b>Note:</b> This parameter must be set to “No” for Direct IP Calling to work.
Keep-alive Interval	Specifies how often the phone sends a blank UDP packet to the SIP server to keep the “ping hole” on the NAT router to open. The default setting is 20 seconds. The valid range is from 10 to 160.
STUN Server	The IP address or Domain name of the STUN server. STUN resolution results are displayed in the STATUS page of the Web GUI.



	Only non-symmetric NAT routers work with STUN.
<b>Use NAT IP</b>	The NAT IP address used in SIP/SDP messages. This field is blank at the default settings. It should ONLY be used if it is required by your ITSP.
<b>Delay Registration</b>	Configures specific time that the account will be registered after booting up.
<b>Test Password Strength</b>	Only Allow password with some constraints to ensure better security.
<b>Enable Outbound Notification</b>	Configures whether to enable outbound notifications such as Action URL.
<b>Public Mode</b>	
<b>Enable Public Mode</b>	Configures to turn on/off public mode for hot desking feature.
<b>Public Mode Username Prefix</b>	Configures the prefix of the username for public mode login.
<b>Public Mode Username Suffix</b>	Configures the suffix of the username for public mode login.
<b>Allow Multiple Accounts</b>	<p>Configures remaining account with a SIP account and be able to make/receive calls on the configured account even if the user is not logged in to the public mode.</p> <ul style="list-style-type: none"> <li>- If set to "No", then after the user logs in to the public mode account on LCD, only the public mode account can be used on the phone even though there are other configured SIP accounts.</li> <li>- If set to "Yes," then after the user logs in to the public mode account on LCD, other configured SIP accounts on the phone can also be used. Note: <b>Note:</b> This option requires enabling public mode to take effect.</li> </ul>
<b>Enable Remote Synchronization</b>	If enabled, the phone will automatically download the current account's settings from the remote server and upload it to the server.
<b>Server Type</b>	<p>Configures the Server type and protocol used to send requests to the Remote Synchronization Server.</p> <p>This can be set to TFTP, FTP, HTTP</p>
<b>Server Path</b>	Configures the server path for the Remote Synchronization feature.
<b>FTP/HTTP Username</b>	The username for FTP/HTTP server.
<b>FTP/HTTP Password</b>	The password for FTP/HTTP server.
<b>Phone Settings → Call Settings</b>	
<b>General</b>	
<b>Key Mode</b>	<p><b>Account Mode</b></p> <p>In Calling State, each key displays the call status of the corresponding account. Click to switch to the first line under this account or select the account to initiate</p>





	<p>a new call.</p> <p><b>Line Mode</b></p> <p>In Calling State, each key controls a line, and the call line can be switched by pressing the key.</p>
<b>Preferred Default Account</b>	Select the preferred default account when off-hook/on-hook dialing. When selected account is unavailable, system will fall back to use the first available account instead.
<b>Mute Key Functions While Idle</b>	If this feature is enabled, MUTE key will take effect in idle state and future incoming call will be answered with mute.
<b>Last Call Forward Always</b>	If enabled, the number inputted into the ForwardAll feature will be stored the next time you use the ForwardAll softkey. Note: ForwardAll softkey currently only used for account 1.
<b>Show SIP Error Response</b>	Configures to enable SIP error response information displayed on LCD screen.
<b>Do Not Escape # as %23 in SIP URI</b>	Specifies whether to replace # by %23 or not for some special situations. The default setting is "No".
<b>User-Agent Prefix</b>	Configure the prefix in the User-Agent header
<b>Enable Hook Switch</b>	When set to "No", disable hook switch completely; When set to "Yes, except answering call", hook switch cannot be used for answering call.
<b>Contact Source Priority</b>	Configure the priority of the ID source displayed on the phone when incoming/outgoing calls. Select one ID source and click the Up/Down arrow on the right to adjust the order. Note: If the "Caller ID Display" under the account is configured as "Disabled", the caller number cannot be obtained, the phone will only display "Unavailable".
<b>Outgoing</b>	
<b>Click-To-Dial Feature</b>	Enables Click-To-Dial feature. If this feature is enabled, user could click the green dial button on left top corner of phone's Web GUI, then choose the account and dial to the target number. The default setting is "Disabled".
<b>Enable Direct IP Call</b>	Configure to enable direct IP call feature.
<b>Use Quick IP Call Mode</b>	When set to "Yes", users can dial an IP address under the same LAN/VPN segment by entering the last octet of the IP address.
<b>Predictive Dialing Feature</b>	Configures the predictive dialing feature on the call screen.
<b>Predictive Dialing Source</b>	Predictive dialing feature will sequentially search the number based on the selected sources.
<b>On-hook Dial Barging</b>	When the option is set to "Disabled", on-hook dialing won't be interrupted by an incoming call.
<b>Off-hook Auto Dial</b>	Configures the digits to be dialed via the first account when the phone is off



	hook.
<b>Off-hook Auto Dial Delay</b>	Defines the timeout (in seconds) for off-hook auto dial. Valid range is 0-30. If set to 0, it will be dialed out immediately; If set to other values, it will be dialed out after the delay.
<b>Off-hook / On-hook Timeout</b>	If configured, when the phone is in the off-hook or on-hook dialing state, it will go idle after the timeout (in seconds). Valid range is 10 to 60.
<b>Enable Live Keypad</b>	If enable phone will automatically dials out and turns on handsfree mode as soon as a dial pad key or softkey is pressed.
<b>Live Keypad Expiration</b>	Set the Live DialPad expire time, interval is between 2s and 15s, default value is 5s.
<b>Enable Auto Redial</b>	Configures to redial automatically at a later time when the dialed number is currently busy.
<b>Auto Redial Times</b>	Configures the total times to redial if "Auto Redial" is enabled.
<b>Auto Redial Interval</b>	Configures the interval between each redial if "Auto Redial" is enabled.
<b>Bypass Dial Plan Through Call History and Directories</b>	Enable/Disable the dial plan check while dialing through the call history and any phonebook directories.
<b>Enable Call Completion Service</b>	If enabled, phone will automatically redial the previous failed call when the remote party becomes available.
<b>Incoming</b>	
<b>Enable Incoming Call Popup</b>	If enabled, phone will pop up an incoming call window to notify users when there is an incoming call.
<b>Enable Missed Call Notification</b>	If enabled, phone will pop up a window to remind users of a missed call
<b>Return Code When Refusing Incoming Call</b>	<p>When refusing the incoming call. The phone will send the selected type of SIP message of the call. Available options are:</p> <ul style="list-style-type: none"> <li>• <b>Busy (486).</b></li> <li>• <b>Temporarily Unavailable (480).</b></li> <li>• <b>Not found (404).</b></li> <li>• <b>Decline (603).</b></li> </ul> <p>Default setting is "Busy 486".</p>
<b>Allow Incoming Call Before Ringing</b>	This allows incoming calls after dialed but before ringing. This can be used under custom user configuration based on need.
<b>Enable Call Waiting</b>	Disables the call waiting feature. The default setting is "Yes".
<b>Call Waiting Tone</b>	If enabled, phone will play call waiting alert tone when there is an incoming call



	while a call is in progress.
<b>Ring for Call Waiting</b>	Configures the phone to ring instead of playing call waiting tone when handset or headset is used.
<b>Auto Answer Delay</b>	Configures the delay for automatically answering the incoming call. Valid range is 0 to 10 (seconds).
<b>In Call</b>	
<b>Enable In-Call DTMF Display</b>	When set to "No", the DTMF digits entered during a call will not be displayed on LCD.
<b>Enable Sending DTMF via specific MPKs</b>	Allows certain MPKs to send DTMF in-call. This option does not affect Dial DTMF. This option is available for the GRP2604 only.
<b>Show On Hold Duration</b>	If enabled, phone will show the duration of holding a call on the LCD.
<b>Enable Auto Unmute</b>	If enabled, phone will be automatically unmuted when user resumes a call or establishes a new call.
<b>In-Call Dial Number on Pressing Transfer Key</b>	Allows the user to configure the number to be dialed as DTMF when using the TRANSFER button. <b>Note:</b> A, B, C and D are supported to be sent as DTMF.
<b>Enable busy tone remote disconnect</b>	If enabled, phone will play busy tone when call is disconnected remotely.
<b>Enable Mute Key in Call</b>	When this feature is disabled, the desk phone user cannot mute his/her microphone during a call.
<b>Transfer</b>	
<b>Enable Transfer</b>	This option is to configure to enable call transfer feature
<b>Hold Call before Completing Transfer</b>	When set to "No", phone will neither hold the current call-in transfer window nor hold the call with the transfer target before referring the call in the attended transfer.
<b>Attended transfer mode</b>	If set to "Static", attended transfer can only be performed with established calls. If set to "Dynamic", attended transfers can be performed with established calls or be initiated during the transfer process. This option does not affect the user's ability to perform blind transfers.
<b>DND</b>	
<b>Enable DND Feature</b>	If set to "No", a user cannot turn on Do Not Disturb feature via MUTE key, MPK, or menu on LCD  :Toggle the DND switch to activate/Deactivate the DND from the Web interface
<b>Return Code When</b>	When DND is enabled, the phone will send the selected type of SIP message.



<b>Enable DND</b>	<p>Available options are:</p> <ul style="list-style-type: none"> <li>• <b>Busy (486).</b></li> <li>• <b>Temporarily Unavailable (480).</b></li> <li>• <b>Not found (404).</b></li> <li>• <b>Decline (603).</b></li> </ul> <p>Default setting is "Temporarily Unavailable (480)".</p>
<b>Override DND</b>	<p>Configures to override the local DND function.</p> <ul style="list-style-type: none"> <li>• If set to "Off", the local DND function is normal;</li> <li>• if set to "Allow All", the local DND function is invalid;</li> <li>• if set to "Allow Only Contacts", when the local DND function is enabled, only local contacts and the configured override numbers can call in;</li> <li>• If set to "Allow Override Numbers", when the local DND is turned on, only the configured coverage numbers can call in.</li> </ul> <p>The default setting is "Off".</p>
<b>Override DND Numbers</b>	Configures the numbers to override the local DND function.
<b>Conference</b>	
<b>Enable Conference</b>	This option is to configure to enable the conference feature.
<b>Hold Call before Adding Conferee</b>	Configures whether to put current call on hold when adding new member to conference. If set to "Yes", the current call will be put on hold when the host presses conference or add key to invite new member. When the invited member answers the call and agrees to attend conference, the host needs to manually resume the conference with the new member added. If set to "No", the current call will not be put on hold and the invited member will join meeting automatically after answering the call.
<b>BLF</b>	
<b>Enable BLF Pickup Screen</b>	Configures to show a softkey which leads to a monitor screen when a monitoring BLF line is ringing.
<b>Enable BLF Pickup Sound</b>	Configures to play sound when a monitoring BLF line is ringing.
<b>Hide BLF Remote Status</b>	Configures to hide the status information of the monitored line.
<b>IM</b>	
<b>Enable IM Popup</b>	If enabled, the phone will show a popup upon receiving an IM.
<b>Instant Message Popup Timeout</b>	Configures the number of seconds that the message will remain on screen.
<b>Play Tone on Receiving IM</b>	Configures to play a short tone when phone receives an IM during idle state.



**Phone setting → Ringtone**

<b>Call Progresses Tones:</b> <ul style="list-style-type: none"> <li>• System Ring Tone</li> <li>• Dial Tone</li> <li>• Second Dial Tone</li> <li>• Message Waiting</li> <li>• Ring Back Tone</li> <li>• Call Waiting Tone</li> <li>• Busy Tone</li> <li>• Reorder Tone</li> </ul>	<p>Configures ring or tone frequencies based on parameters from local telecom. The default value is North American standard. Frequencies should be configured with known values to avoid uncomfortable high pitch sounds.</p> <p><b>Syntax:</b> f1=val,f2=val[,c=on1/off1[-on2/off2[-on3/off3]]];          (Frequencies are in Hz and cadence on and off are in 10ms)</p> <p>ON is the period of ringing (“On time” in ‘ms’) while OFF is the period of silence. To set a continuous ring, OFF should be zero. Otherwise, it will ring ON ms and a pause of OFF ms and then repeat the pattern. Up to three cadences are supported.</p>
<b>Call Waiting Tone Gain</b>	<p>Configures the call waiting tone gain to adjust call waiting tone volume (Low, Medium, or High). The default setting is “Low”.</p>
<b>Lock Speaker Volume</b>	<p>Lock volume adjustment when the option is enabled so it cannot be changed from phone LCD. The option can be set to: “No”, “Ring”, “Talk” or “Both”. Default setting is “No”.</p>

**Phone setting → Multicast Paging**

<b>Multicast Paging Function</b>	<p>Enable or disable multicast paging</p>
<b>Allowed In DND Mode</b>	<p>Allow Multicast Paging when DND mode is enabled.          Default Setting is “No”.</p>
<b>Paging Barge</b>	<p>During active call, if incoming multicast page is higher priority (1 being the highest) than this value, the call will be held, and multicast page will be played. The default setting is “Disabled”.</p>
<b>Paging Priority Active</b>	<p>If enabled, during a multicast page if another multicast is received with higher priority (1 being the highest) that one will be played instead. The default setting is “Enabled”.</p>
<b>Multicast Channel Number</b>	<p>Multicast Channel Number (0-50). 0 for normal RTP packets, 1-50 for Polycom multicast format packets.</p>
<b>Multicast Paging Codec</b>	<p>The codec for sending multicast pages, there are 5 codecs could be used: G.731.1 PCMU, PCMA, G.726-32, G.729A/B, G.722 (wide band). Default setting is “PCMU”.</p>
<b>Multicast Sender ID</b>	<p>Outgoing caller ID that displays to your page group recipients (for multicast channel 1 – 50).</p>
<b>Multicast Listening</b>	<p>Defines multicast listening addresses and labels. For example:</p> <ul style="list-style-type: none"> <li>• “Listening Address” should match the sender’s Value such as</li> </ul>



“237.11.10.11:6767”

- “Label” could be the description you want to use.

For details, please check the “Multicast Paging User Guide” on our Website.

## Network Settings Page Definitions

Table 11: Network Page Definitions

Network Settings → Ethernet Settings	
<b>Internet Protocol</b>	Selects “IPv4 Only”, “IPv6 Only”, “Both, prefer IPv4” or “Both, prefer IPv6”. The default setting is “IPv4 only”.
<b>IPv4 Address</b>	
<b>IPv4 Address</b>	Allows users to configure the appropriate network settings on the phone to obtain IPv4 address. Users could select “DHCP”, “Static IP” or “PPPoE”. By default, it is set to “DHCP”.
<b>Host name (Option 12)</b>	Specifies the name of the client. This field is optional but may be required by Internet Service Providers.
<b>Vendor Class ID (Option 60)</b>	Used by clients and servers to exchange vendor class ID.
<b>IPv4 Address</b>	Enter the IP address when static IP is used.
<b>Subnet Mask</b>	Enter the Subnet Mask when static IP is used for IPv4.
<b>Gateway</b>	Enter the Default Gateway when static IP is used for IPv4.
<b>PPPoE Account ID</b>	Enter the PPPoE account ID.
<b>PPPoE Password</b>	Enter the PPPoE Password.
<b>PPPoE Service Name</b>	Enter the PPPoE Service Name.
<b>DNS Server 1</b>	Enter the DNS Server 1 when static IP is used for IPv4.
<b>DNS Server 2</b>	Enter the DNS Server 2 when static IP is used for IPv4.
<b>Preferred DNS Server</b>	Enters the Preferred DNS Server for IPv4.
<b>IPv6 Address</b>	
<b>IPv6 Address Type</b>	Allows users to configure the appropriate network settings on the phone to obtain IPv6 address. Users could select “Auto-configured” or “Statically configured” for the IPv6 address type.
<b>Static IPv6 Address</b>	Enter the static IPv6 address when Full Static is used in “Statically configured” IPv6 address type.



<b>IPv6 Prefix Length</b>	Enter the IPv6 prefix length when Full Static is used in "Statically configured" IPv6 address type.
<b>IPv6 Prefix (64 bits)</b>	Enter the IPv6 Prefix (64 bits) when Prefix Static is used in "Statically configured" IPv6 address type.
<b>DNS Server 1</b>	Enter the DNS Server 1 for IPv6.
<b>DNS Server 2</b>	Enter the DNS Server 2 for IPv6.
<b>Preferred DNS server</b>	Enter the Preferred DNS Server for IPv6.
<b>802.1X</b>	
<b>802.1X mode</b>	Allows the user to enable/disable 802.1X mode on the phone. The default value is disabled. To enable 802.1X mode, this field should be set to EAP-MD5, users may also choose EAP-TLS, or EAP-PEAPv0/MSCHAPv2.
<b>802.1X Identity</b>	Enter the Identity information for the 802.1x mode. <b>Note:</b> Letters, digits and special characters including @ and – are accepted.
<b>MD5 Password</b>	Enter the MD5 Password for the 802.1X mode. <b>Note:</b> Letters, digits and special characters including @ and – are accepted.
<b>802.1X CA Certificate</b>	Uploads / deletes the 802.1X CA certificate to the phone; or delete existed 802.1X CA certificate from the phone.
<b>802.1X Client Certificate</b>	Uploads / deletes 802.1X Client certificate to the phone; or delete existed 802.1X Client certificate from the phone.
<b>Network Settings → Wi-Fi Settings (GRP2602W Only)</b>	
<b>Wi-Fi Function</b>	Enables / Disables the Wi-Fi on the phone. Three options are available: <ul style="list-style-type: none"> <li>• <b>Enable:</b> Enables Wi-Fi to connect to Wi-Fi network.</li> <li>• <b>Disable:</b> Disables Wi-Fi. User has ability to enable Wi-Fi from LCD Menu.</li> <li>• <b>Disable &amp; Hide Menu from LCD:</b> Disables Wi-Fi and hides "Wi-Fi Settings" menu from phone LCD.</li> </ul>
<b>Wi-Fi Band</b>	Set the type of Wi-Fi Band whether its 2G or 5G or 5G&2G.
<b>Country Code</b>	Configures Wi-Fi country code.
<b>ESSID</b>	This parameter sets the ESSID for the Wireless network. Press "Scan" to scan for the available wireless network. Click on "Connect" and enter the authentication credentials of the Wi-Fi network to connect to. Users can connect to hidden networks by pressing on "Add Network" and configure: <ul style="list-style-type: none"> <li>• <b>ESSID:</b> Configure the hidden ESSID name.</li> <li>• <b>Security Mode:</b> Defines the security mode used for the wireless network when the SSID is hidden. Default is "None".</li> </ul>





	<ul style="list-style-type: none"> <li>• <b>Password:</b> Determines the password for the selected Wi-Fi network.</li> <li>• <b>Advanced:</b> Configures IPv4 and IPv6 modes.</li> </ul>
<b>Network Settings → OpenVPN® Settings</b>	
<b>OpenVPN® Enable</b>	Enables/Disables OpenVPN® feature. Default is “No”.
<b>Manual Import</b>	
<b>Import OpenVPN® Configuration</b>	Import the configuration file from the current computer. After importing, the local configuration will be overwritten and OpenVPN® function is automatically enabled.
<b>Local configuration</b>	
<b>OpenVPN® Server Address</b>	Specify the IP address or FQDN for the OpenVPN® Server.
<b>OpenVPN® Port</b>	Specify the listening port of the OpenVPN® server. The valid range is 1 – 65535. The default value is “1194”.
<b>OpenVPN® Transport</b>	Specify the Transport Type of OpenVPN® whether UDP or TCP. The default value is “UDP”.
<b>OpenVPN® CA</b>	Click on “Upload” to upload the Certification Authority of OpenVPN®. For a new upload, users could click on “Delete” to erase the last certificate, and then upload a new one.
<b>OpenVPN® Certificate</b>	Click on “Upload” to upload OpenVPN® certificate. For a new upload, users could click on “Delete” to erase the last certificate, and then upload a new one.
<b>OpenVPN® Client Key</b>	Click on “Upload” to upload OpenVPN® Key. For a new upload, users could click on “Delete” to erase the last certificate, and then upload a new one.
<b>OpenVPN® Cipher Method</b>	<p>Specifies the Cipher method used by the OpenVPN® server. The available options are:</p> <ul style="list-style-type: none"> <li>• <b>Blowfish</b></li> <li>• <b>AES-128</b></li> <li>• <b>AES-256</b></li> <li>• <b>Triple-DES</b></li> </ul> <p>The default setting is “Blowfish”.</p>
<b>OpenVPN® Username</b>	Configures the optional username for authentication if the OpenVPN server supports it.
<b>OpenVPN® Password</b>	Configures the optional password for authentication if the OpenVPN server supports it.





<b>OpenVPN® Comp-Izo</b>	Configures enable/disable the LZO compression. When the LZO Compression is enabled on the OpenVPN server, you must turn on it at the same time. Otherwise, the network will be abnormal. Default value is YES.
<b>Additional Options</b>	Additional options to be appended to the OpenVPN® config file, separated by semicolons. For example, comp-izo no;auth SHA256 <b>Note:</b> Please use this option with caution. Make sure that the options are recognizable by OpenVPN® and do not unnecessarily override the other configurations above.

## Network Settings → Advanced Settings

### Advanced Network Settings

<b>Enable LLDP</b>	Controls the LLDP (Link Layer Discovery Protocol) service. The default setting is “Enabled”.
<b>LLDP TX Interval</b>	Defines LLDP TX Interval (in seconds). Valid range is 1 to 3600. The default setting is “60”.
<b>Enable CDP</b>	Enables/Disables CDP “Cisco Discovery Protocol”. The default setting is “Enabled”.
<b>Layer 3 QoS for SIP</b>	Defines the Layer 3 QoS parameter for SIP. This value is used for IP Precedence, Diff-Serv or MPLS. The default value is 26.
<b>Layer 3 QoS for RTP</b>	Defines the Layer 3 QoS parameter for RTP. This value is used for IP Precedence, Diff-Serv or MPLS. The default value is 46.
<b>Enable DHCP VLAN</b>	Enables auto configure for VLAN settings through DHCP. Disabled by default.
<b>Enable Manual VLAN Configuration</b>	Enables/disables manual VLAN configuration. When this option is set to Disabled, the phone will bypass VLAN configuration and only use the DHCP VLAN to configure VLAN tag and priority. Default is “Enabled”.
<b>Layer 2 QoS 802.1Q/VLAN Tag</b>	Assigns the VLAN Tag of the Layer 2 QoS packets. The valid range is 0 – 4094. The default value is 0.
<b>Layer 2 QoS 802.1p Priority Value</b>	Assigns the priority value of the Layer2 QoS packets. The valid range is 0 – 7. The default value is 0.
<b>Maximum Transmission Unit (MTU)</b>	Defines the MTU in bytes. The valid range is 576 – 1500. The default value is 1500 bytes.
<b>PC Port Mode</b>	
<b>PC Port Mode</b>	Configure the PC port mode. When set to “Mirrored”, the traffic in the LAN port will go through PC port as well and packets can be captured by connecting a



	PC to the PC port. The default setting is “Enabled”.
<b>PC Port VLAN Tag</b>	Assigns the VLAN Tag of the PC port. The valid range is 0 – 4094. The default value is 0.
<b>PC Port Priority Value</b>	Assigns the priority value of the PC port. The valid range is 0 – 7. The default value is 0.
<b>Proxy</b>	
<b>HTTP Proxy</b>	Specifies the HTTP proxy URL for the phone to send packets to. The proxy server will act as an intermediary to route the packets to the destination.
<b>HTTPS Proxy</b>	Specifies the HTTPS proxy URL for the phone to send packets to. The proxy server will act as an intermediary to route the packets to the destination.
<b>Bypass Proxy for</b>	Configures the destination IP address where no proxy server is needed. The phone will not use a proxy server when sending packets to the specified destination IP address.
<b>Remote Control</b>	
<b>Action URI Support</b>	Indicate whether the phone is enabled to receive and handle Action URI request.
<b>Remote-Control Pop-up Window Support</b>	Indicate whether the phone is enabled to pop up Allow Remote Control window.
<b>Action URI Allowed IP List</b>	List of allowed IP addresses from which the phone receives the Action URI
<b>CSTA Control</b>	Indicates whether CSTA Control feature is enabled. Change of this configuration will need the system reboot to make it take effect.
<b>CTI Settings</b>	
<b>Affinity Support</b>	Indicate whether Affinity feature is supported.
<b>Preferred Account</b>	Affinity target SIP account.
<b>Network Settings → SNMP Settings</b>	
<b>Enable SNMP</b>	Enable/Disable SNMP service. Default is No.
<b>Version</b>	Choose between (Version 1, Version 2, or Version 3).
<b>Port</b>	Listening Port of SNMP daemon (Default 161).
<b>Community</b>	Name of SNMP community.



<b>Security Level</b>	<p><b>noAuthUser:</b> Users with security level noAuthnoPriv and context name as noAuth.</p> <p><b>AuthUser:</b> Users with security level authNoPriv and context name as auth.</p> <p><b>privUser :</b> Users with security level authPriv and context name as priv.</p>
<b>SNMP Username</b>	Username for SNMPv3.
<b>Authentication Protocol</b>	Select the Authentication Protocol: "None" or "MD5" or "SHA."
<b>Privacy Protocol</b>	Select the Privacy Protocol: "None" or "AES" or "DES".
<b>Authentication Key</b>	Enter the Authentication Key for SNMPv3.
<b>Privacy Key</b>	Enter the Privacy Key for SNMPv3.
<b>SNMP Trap Version</b>	Choose the Trap version of the SNMP trap receiver.
<b>SNMP Trap IP</b>	IP address of trap destination.
<b>SNMP Trap port</b>	Port of Trap destination (Default 162)
<b>SNMP Trap Interval</b>	Time interval between traps (Default is 5).
<b>SNMP Trap Community</b>	Community string associated to the trap. It must match the community string of the trap receiver.
<b>SNMP Trap Username</b>	Username for SNMPv3 Trap.
<b>Trap Security Level</b>	<p><b>noAuthUser:</b> Users with security level noAuthnoPriv and context name as noAuth.</p> <p><b>authUser:</b> Users with security level authNoPriv and context name as auth.</p> <p><b>privUser:</b> Users with security level authPriv and context name as priv.</p>
<b>Trap Authentication Protocol</b>	Select the Authentication Protocol: "None" or "MD5" or "SHA".
<b>Trap Privacy Protocol</b>	Select the Privacy Protocol: "None" or "AES/AES128" or "DES".
<b>Trap Authentication Key</b>	Enter the Trap Authentication Key.
<b>Trap Privacy Key</b>	Enter the Trap Privacy Key.

## Programmable keys Page Definitions

Table 12: Programmable Keys Page Definitions

Programmable keys → Multi-Purpose Keys (GRP2604 only)	
Keys Settings	
<b>Mode</b>	<ul style="list-style-type: none"> <li> <b>Speed Dial</b>            Select the Account to dial from. And enter the Speed Dial number in the Value field to be dialed or enter the IP address to set the Direct IP call as         </li> </ul>



Speed Dial.

- **Busy Lamp Field (BLF)**

Select the Account to monitor the BLF status. Enter the extension number in the Value field to be monitored.

- **Presence Watcher**

This option must be supported by a presence server, and it is tied to the “Do Not Disturb” status of the phone’s extension.

The phone will change the icon and LED color based on the extension status.

- **Eventlist BLF**

This option is similar to the BLF option but in this case the PBX collects the information from the phones and sends it out in one single notify message. PBX server has to support this feature.

- **Speed Dial via active account**

Similar to Speed Dial but it will dial based on the current active account. For example, if the phone is offhook and account 2 is active, it will call the configured Speed Dial number using account 2

- **Dial DTMF**

Enter a series of DTMF digits in the Value field to be dialed during the call. “Enable MPK Sending DTMF” has to be set to “Yes” first.

- **Voicemail**

Select Account and enter Voicemail access number in the Value field.

- **Call Return**

The last answered calls can be dialed out by using Call Return. The Value field should be left blank. Also, this option is not binding to the account and the call will be returned based on the account with the last answered call.

- **Transfer**

Select Account and enter the number in the Value field to be transferred (blind transfer) during the call.

- **Call Park**

Select Account and enter the call park extension in the Value field to



park/pick up the call.

- **LDAP Search**

This option is to narrow the LDAP search scope. Enter the LDAP search base in the Description field. It could be the same or different from the Base in LDAP configuration under Advanced Settings. The Base in LDAP configuration will be used if the Description field is left blank. Enter the LDAP Name/Number filter in the Value field.

For example:

If users set MPK 1 as “LDAP Search” for “Account 1”, and set filters:

**Description** -> ou=video,ou=SZ,dc=grandstream,dc=com

**Value** -> sn=Li

Since the Base for LDAP server configuration is: “dc=grandstream,dc=com”, “ou=video,ou=SZ” is added to narrow the LDAP search scope. “sn=Li” is the example to filter the last name.

- **Conference**

Allow user to set their Multi-Purpose Key to “Conference” mode to trigger a conference.

By setting the extension number in the value box, the users will be able to activate a 3-way conference by simply press the assigned MPK button.

- **Multicast Paging**

Allows the user to configure the address to send a multicast page to.

- **Call Log**

Select Account and enter account number in the Value field to allow configuration of call log for other extension.

- **Monitored Call Park**

Select account from Account field and enter the call park extension in the Value field to park/pick up the call, and also monitor the parked call via Line Key’s light.

- **Menu**

Select this feature in order to display the Menu from the MPK buttons, no field dis required for configuration.

- **Information**

Select this feature in order to display the Information popup to show the firmware version, MAC address, IP address and IP Settings from the MPK



	<p>buttons, no field dis required for configuration.</p> <ul style="list-style-type: none"> <li> <b>Message</b>            Select this feature in order to display the Message menu from the MPK buttons, no field dis required for configuration.         </li> <li> <b>Forward</b>            Set the MPK Button to perform call forwarding to the destination number configured on the "Value Field". During ringing press the button to perform the call forward.         </li> <li> <b>DND</b>            Press the configured key to enabled/Disable DND.         </li> <li> <b>Redial</b>            On this mode, the configured key can be used to redial numbers.         </li> <li> <b>Presence Eventlist</b>            This option is similar to the Presence Watcher option but in this case the PBX collects the information from the phones and sends it out in one single notify message.  <b>Note:</b> The PBX server has to support this feature.         </li> <li> <b>Provision</b>            Select this feature in order to make the phone trigger an instant provisioning.         </li> </ul>
<b>Account</b>	Select the account to be associated with the configured MPK.
<b>Value</b>	Enter the value to be associated with the configured MPK
<b>Label</b>	Enter the name to be associated with the MPK.
<b>Preview</b>	Shows a preview of the configured MPKs label. After saving, you can print the card style in the preview. For more info about how to install the BLF paper label check the <b>Quick Installation guide</b> .
<b>Basic Settings</b>	
<b>Transfer Mode via MPK</b>	Perform blind transfer, attended transfer, or a new call with the specific in the Value field when a user presses "Transfer" multiple-purpose key
<b>Enable Transfer via Non-Transfer MPK</b>	MPK with type BLF, Speed dial, etc, will perform as transfer MPK under active call
<b>Programmable Keys → Virtual Multi-Purpose Keys</b>	



<b>VPKs</b>	<p>Allows the user to configure VPKs with modes such as Shared line, BLF and Speed Dial. Modes:</p> <p>None, SpeedDial, BLF, PresenceWatcher, EventlistBLF, SpeedDialViaActiveAccount, DialDTMF, VoiceMail, CallReturn, Transfer, CallPark, Intercom, LDAPSearch, Conference, MulticastPaging, CallLog, MonitoredCallPark, Menu, Information, Message, Forward, DND, Redial, MulticastListenAddress, EventListPresence, Provision, Default, SharedLine, Multicast Paging Address.</p>
<b>Programmable Keys → Idle screen softkey</b>	
<b>Custom Idle Screen Softkey Layout</b>	<p>Enables/disables custom softkey layout. Default is disabled.</p>
<b>Custom Softkey</b>	<p>Press on <b>Add Custom Softkey</b> radio button to add/configure up to 3 custom softkeys. Supported key modes are speed dial, speed dial via active account and voicemail.</p>
<b>Custom Softkey Layout</b>	<p>The softkeys listed under “Enabled” tab is displayed on the phone’s idle screen. Select the softkey from “Available” list to enable it. Up to 6 softkeys can be selected, and 23 softkeys are available.</p>
<b>Programmable Keys → Call screen softkeys</b>	
<b>Custom Call Screen Softkey Layout</b>	<p>Enables/disables custom softkey layout. Default is disabled.</p>
<b>Enforce Softkey Layout Position</b>	<p>Whether to enforce the custom softkey layout position. When set to 'YES', GUI will still preserve the space if the configured softkey is unable to show. Default is disabled.</p>
<b>Custom Softkey</b>	<p>Press on <b>Add Custom Softkey</b> radio button to add/configure up to 3 custom softkeys. Supported key modes are speed dial, speed dial via active account and voicemail.</p>
<b>Custom Softkey Layout</b>	<ul style="list-style-type: none"> <li>• <b>Dialing State</b>            Custom softkey layout when device is under DIALING state.  <b>Available softkeys:</b> EndCall, Backspace, Contacts, Call History.</li> <li>• <b>Ringling State</b>            Custom softkey layout when device is under RINGING state.  <b>Available softkeys:</b> Answer, Reject, Forward, Ring silence.</li> </ul>



- **Calling State**

Custom softkey layout when device is under CALLING state.

**Available softkeys: End Call, Conference.**

- **Call Connected State**

Custom softkey layout when device is under CALL CONNECTED state.

**Available softkeys:** End Call, Conference, New Call, Swap, Transfer, call park, Call record, Noise shield, BS Call Center.

- **On Hold State**

Custom softkey layout when device is under ON HOLD state.

**Available softkeys: End Call, Resume, New Call, Conference, Swap, Transfer, BS call center.**

- **Call Failed State**

Custom softkey layout when device is under CALL FAILED state.

**Available softkeys:** EndCalls, Redial.

- **Transfer State**

Custom softkey layout when device is under TRANSFER state.

**Available softkeys:** Cancel, Backspace, Transfer, Contacts, Call History.

- **Conference State**

Custom softkey layout when device is under CONFERENCE state.

**Available softkeys:** Cancel, Dial, Backspace, Contacts, Call History.

- **Conference Connected State**

Custom softkey layout when device is under CONFERENCE CONNECTED state.

**Available softkeys:** EndCall, Conference Info, Hold, Add, Noise Shield.

- **Onhook Dialing State**

Custom softkey layout when device is under ONHOOK DIALING state

**Available softkeys:** End Call, Back Space, Dial, Contacts, Call History.

The softkeys listed under “Enabled” tab will be displayed on the phone’s idle screen. Select the softkey from “Available” list to enable it.

### Programmable Keys → Advanced settings

#### Auto Provision List Starting Point

Configures the type of keys that will be used first on Auto Provision Eventlist BLF feature.





<b>Transfer Mode via Programmable Keys</b>	Configures the transfer mode to use when pressing the "Transfer" MPK. Choose from <b>Blind Transfer</b> , <b>Attended Transfer</b> or <b>New Call, All for selection</b> .
<b>Enable Transfer via Non-Transfer Programmable Keys</b>	MPK with type BLF, Speed dial, etc., will perform as transfer MPK under active call.
<b>Allow Programmable Key Configuration via LCD</b>	Configure to enable Programmable Key configuration via LCD by pressing and holding MPKs/VPKs.

## System Settings Page Definitions

Table 13: System Settings Page Definitions

System Settings → Time and Language	
<b>Date and Time</b>	
<b>NTP Server</b>	Defines the URL or IP address of the NTP server. The phone may obtain the date and time from the server. The default setting is "pool.ntp.org".
<b>Secondary NTP Server</b>	Defines the URL or IP address of the NTP server. The phone may obtain the date and time from the server. Allow user to configure 2 NTP server domain names. GRP will loop through all the IP addresses resolved from them.
<b>NTP Update Interval</b>	Time interval for updating time from the NTP server. Valid time value is in between 5 to 1440 minutes. The default setting is "1440" minutes.
<b>Enable Authenticated NTP</b>	Configures whether to enable NTP authentication. If enabled, a cryptographic signature appended to each network packet. If the key is incorrectly configured, the phone will refuse to use the time provided by the NTP server.
<b>Allow DHCP Option 42 Override NTP Server</b>	Defines whether DHCP Option 42 should override NTP server or not. When enabled, DHCP Option 42 will override the NTP server if it is set up on the LAN. The default setting is "No".
<b>Time Zone</b>	Configures the date/time used on the phone according to the specified time zone. The default setting is "Auto".
<b>Allow DHCP Option 2 to Override Time Zone Setting</b>	Allows device to get provisioned for Time Zone from DHCP Option 2 in the local server. The default setting is enabled.
<b>Self-Defined Time Zone</b>	This parameter allows the users to define their own time zone, when "Time Zone" parameter is set to "Self-Defined Time Zone".



	<p>The syntax is: <b>std offset dst [offset], start [/time], end [/time]</b></p> <p>Default is set to: <b>MTZ+6MDT+5,M4.1.0,M11.1.0</b></p> <p><b>MTZ+6MDT+5</b></p> <p>This indicates a time zone with 6 hours offset with 1 hour ahead (when daylight saving) which is U.S central time. If it is positive (+) if the local time zone is west of the Prime Meridian (A.K.A: International or Greenwich Meridian) and negative (-) if it is east.</p> <p><b>M4.1.0,M11.1.0</b></p> <p>The 1<sup>st</sup> number indicates Month: 1,2,3..., 12 (for Jan, Feb, ..., Dec)</p> <p>The 2<sup>nd</sup> number indicates the nth iteration of the weekday: (1<sup>st</sup> Sunday, 3<sup>rd</sup> Tuesday...)</p> <p>The 3<sup>rd</sup> number indicates weekday: 0,1,2,...,6( for Sun, Mon, Tues, ... ,Sat)</p> <p>Therefore, this example is the DST which starts from the First Sunday of April to the 1<sup>st</sup> Sunday of November.</p>
<b>Date Display Format</b>	<p>Configures the date display format on the LCD. The following formats are supported.</p> <ul style="list-style-type: none"> <li>• <b>yyyy-mm-dd</b>: 2019-03-02</li> <li>• <b>mm-dd-yyyy</b>: 03-02-2019</li> <li>• <b>dd-mm-yyyy</b>: 02-03-2019</li> <li>• <b>dddd, MMMM dd</b>: Saturday, March 02</li> <li>• <b>MMMM dd, dddd</b>: March 02, Saturday</li> </ul> <p>The default setting is yyyy-mm-dd.</p>
<b>Time Display Format</b>	<p>Configures the time display in 12-hour or 24-hour format on the LCD. The default setting is in 12-hour format.</p>
<b>Language</b>	
<b>Display Language</b>	Selects display language on the phone.
<b>System Settings → Security Settings</b>	
<b>SSH Access</b>	
<b>Enable SSH</b>	<p>Disables SSH access.</p> <p>The default setting is “Yes”</p>
<b>SSH Public Key</b>	Enable the device to use public key authentication as an alternative option to password authentication.



<b>Factory reset security level</b>	<p>Configure the password inquiry for factory reset.</p> <p>If set to "<b>Default</b>", Password is needed when configuration via keypad menu is not Unrestricted.</p> <p>If set to "<b>Always Require Password</b>", Password is needed no matter what configuration via keypad menu mode is.</p> <p>If set to "<b>No Password Required</b>", No password is needed no matter what configuration via keypad menu mode is.</p>
<b>Wi-Fi Settings Security Level</b>	<p>Configure if the password is required for the Wi-Fi settings.</p> <ul style="list-style-type: none"> <li>• <b>Default:</b> Password is needed when configuration via keypad menu is not restricted.</li> <li>• <b>Always Require Password:</b> Password is always required no matter what configuration via keypad menu mode is.</li> <li>• <b>No Password Required:</b> No password is needed no matter what configuration via keypad menu mode is.</li> </ul>
<b>LCD Access</b>	
<b>Configuration via Keypad Menu</b>	<p>Configures access control for keypad Menu settings.</p> <ul style="list-style-type: none"> <li>• <b>Unrestricted:</b> all options on LCD menu can be accessed;</li> <li>• <b>Basic settings only:</b> only options for basic setting can be displayed on LCD menu;</li> <li>• <b>Constraint Mode:</b> accessing options other than basic settings will require permission;</li> <li>• <b>Locked Mode:</b> MENU is disabled</li> </ul>
<b>Factory Reset Security Level</b>	<p>Configure the password inquiry for factory reset. If set to "Default", Password is needed when configuration via keypad menu is not Unrestricted. If set to "Always Require Password", Password is needed no matter what configuration via keypad menu mode is. If set to "No Password Required", No password is needed no matter what configuration via keypad menu mode is.</p>
<b>Web Access</b>	
<b>HTTP Web Port</b>	<p>Configures the HTTP port under the HTTP web access mode. The valid range is 80 – 65535. The default value is "80".</p>
<b>HTTPS Web Port</b>	<p>Configures the HTTPS port under the HTTPS web access mode. The valid range is 443 – 65535. The default setting is "443".</p>



<b>Web Access Mode</b>	<p>Sets the protocol for web interface.</p> <ul style="list-style-type: none"> <li>• <b>HTTPS</b></li> <li>• <b>HTTP</b></li> <li>• <b>Disabled</b></li> <li>• <b>Both HTTP and HTTPS</b></li> </ul> <p>The default setting is “HTTP”.</p>
<b>Web Access Control</b>	Web access control by using Whitelist or Blacklist on incoming IP addresses
<b>Web Access Control List</b>	Only allow the IP address list as a whitelist or restrict the IP address list as a blacklist to access the Web.
<b>Web Session Timeout</b>	Configures timer to logout web session during idle. The valid range is 2-60 min. The default value is 10 min
<b>Enable User Web Access</b>	Administrator can disable or enable user web access. The default setting is “Enabled”.
<b>Validate Server Certificates</b>	After enabling this feature, phone will validate the server’s certificate. If the server that our phone tries to register on is not on our list, it will not allow server to access the phone.
<b>Web/Restrict mode Lockout Duration</b>	Specifies the time in minutes that the web or LCD login interface will be locked out to user after five login failures. This lockout time is used for web login, and LCD restrict mode admin login. Range is 0-60 minutes. The default setting is “5”.
<b>Web access attempt limit</b>	Configure attempt limit before lockout. Default is 5. Range is 1-10.
<b>User Info Management</b>	
<b>Test Password strength</b>	Checks password strength to ensure better security.
<b>User Password</b>	
<b>New Password</b>	Set new password for web GUI access as User. This field is case sensitive.
<b>Confirm Password</b>	Enter the new User password again to confirm.
<b>Admin Password</b>	
<b>Current Password</b>	The current admin password is required for setting a new admin password.
<b>New Password</b>	Set new password for web GUI access as Admin. This field is case sensitive.
<b>Confirm Password</b>	Enter the new Admin password again to confirm.
<b>Client certificate</b>	
<b>Minimum TLS Version</b>	Configures the minimum TLS version supported by the phone. Minimum TLS version must be less than or equal to maximum TLS version.



<b>Maximum TLS version</b>	Configures the maximum TLS version supported by the phone. Maximum TLS version must be greater than or equal to minimum TLS version.
<b>SIP TLS Certificate</b>	SSL Certificate used for SIP Transport in TLS/TCP.
<b>SIP TLS Private Key</b>	SSL Private key used for SIP Transport in TLS/TCP.
<b>SIP TLS Private Key Password</b>	SSL Private key password used for SIP Transport in TLS/TCP.
<b>Custom Certificate</b>	The uploaded custom certificate will be used for SSL/TLS communication instead of the phone default certificate.
<b>Trusted CA Certificate</b>	
<b>Trusted CA Certificates (1 – 6)</b>	Allows to upload and delete the CA Certificate file to phone. <b>Note:</b> Users can either upload the file directly from web or they can choose to provision it from their cfg.xml file.
<b>Load CA Certificates</b>	Phone will verify the server certificate based on the built-in, custom or both trusted certificates list. The default setting is “Default Certificates”.
<b>Keypad Lock</b>	
<b>Enable Keypad Locking</b>	If set to "Yes", the keypad can be locked by pressing and holding the STAR * key for about 4 seconds. And will also allow automatic locking.
<b>Keypad Lock Type</b>	<p>If set to <b>“All Keys”</b>, all keys will be locked, and no emergency calls can be made.</p> <p>If set to <b>“Customized”</b>, only “Functional Keys” will be locked but you are still allowed to make emergency calls. The keys will be locked based on the user configuration. These are the options available for customization:</p> <ul style="list-style-type: none"> <li>• <b>Keys to Lock When Idle:</b> Customize the keys you want to lock when the phone is idle.</li> <li>• <b>Keys to Lock When in Call:</b> Customize the keys you want to unlock when the phone is on a call.</li> <li>• <b>Password to Lock/Unlock:</b> Configure the password to lock/unlock the keypad</li> <li>• <b>Keypad Lock Timer:</b> Configure the timeout (in seconds) of idle screen for locking the keypad. Valid range is 0 to 3600.</li> <li>• <b>Emergency:</b> Defines the emergency call numbers. If multiple emergency numbers are entered, they should be separated by a comma ‘,’.</li> </ul>



<b>Password to Lock/Unlock</b>	Configures the password to lock/unlock the keypad.
<b>Keypad Lock Timer</b>	Configures the timeout (in seconds) of idle screen for locking keypad. Valid range is 0 to 3600.
<b>Emergency</b>	Defines emergency call numbers. If multiple emergency call numbers are entered, they should be separated by ','.

### System Settings → Preferences

#### Display Control

##### LCD

<b>Backlight Brightness: Active</b>	Configures the LCD brightness when the phone is active. Valid range is 0 to 8 where 0 is off and 8 is the brightest.
<b>Backlight Brightness: Idle</b>	Configures the LCD brightness when the phone is idle. Valid range is 0 to 8 where 0 is off and 8 is the brightest.
<b>Active Backlight Timeout</b>	Configures the timeout interval of the LCD backlight. The valid range is 0 to 90.
<b>Enable Missed Call Backlight</b>	If set to "Yes", LCD backlight will be turned on when there is a missed call on the phone.

##### LED

<b>New Message LED Indicator</b>	Configures the LED indicator mode when there is new voicemail or text message on the phone. If set to "Off", LED indicator will not light up.
<b>Line LED Color Scheme</b>	Configures line key LED color scheme to Default or Light up mode. <ul style="list-style-type: none"> <li>• <i>Default: off(idle)/green(in use)</i></li> <li>• <i>Light up: green(idle)/red(in use)</i></li> </ul>

#### Audio Control

<b>Enable warning Tone</b>	Configures whether to enable the warning tone of the phone. If disabled, all pop-up and notifications will play no tone.
----------------------------	--

#### Headset

<b>Headset Key Mode</b>	<p>When headset is connected to the phone, users could use the HEADSET button in "Default Mode" or "Toggle Headset/Speaker".</p> <ul style="list-style-type: none"> <li>• <b>Default Mode:</b> <ul style="list-style-type: none"> <li>➤ When the phone is in idle, press HEADSET button to off hook the phone and make calls by using headset. Headset icon will display on the screen in dialing/talking status.</li> </ul> </li> </ul> <p>When there is an incoming call, press HEADSET button to pick up the</p>
-------------------------	---



	<p>call-using headset.</p> <ul style="list-style-type: none"> <li>➤ When there is an active call using headset, press HEADSET button to hang up the call.</li> <li>➤ When Speaker/Handset is being used in dialing/talking status, press HEADSET button to switch to headset. Press it again to hang up the call. Or, press speaker/Handset to switch back to the previous mode.</li> </ul> <ul style="list-style-type: none"> <li>• <b>Toggle Headset/Speaker:</b></li> </ul> <p>When the phone is in idle, press HEADSET button to switch to Headset mode. The headset icon will display on the left side of the screen.</p> <ul style="list-style-type: none"> <li>➤ In this mode, if pressing Speaker button or Line key to off hook the phone, headset will be used.</li> </ul> <p>When there is an active call, press HEADSET button to toggle between Headset and Speaker.</p>
<b>Headset Type</b>	Selects whether the connected headset is normal RJ11 headset, Plantronics EHS, Jabra EHS, Sennheiser EHS headset.
<b>Always Ring Speaker</b>	Configures to enable or disable the speaker to ring when headset is used on "Toggle Headset/Speaker" mode. If set to "Yes", when the phone is in Headset "Toggle Headset/Speaker" mode, both headset and speaker will ring on incoming call. The default setting is "No".
<b>Group Listen with headset</b>	Allow headset to be able to listen when picked up during a call with headset
<b>Group Listen with Speaker</b>	In a call, phone will display softkey to enable speaker listening when audio mode is set to handset or headset.
<b>Headset TX Gain (dB)</b>	Configures the transmission gain of the headset. The default value is -6dB.
<b>Headset RX Gain (dB)</b>	Configures the receiving gain of the headset. The default value is -6dB.
<b>Enable Headset Noise Shield</b>	When enabled, the remote party will not hear the environmental noise during a call using the headset. Choose according to the TX loudness of the earphone. When the TX loudness of the headset is loud, please select the "Loud Headset", and when the TX loudness of the headset is soft, please select the "Thin Headset". "Moderate Headset" is selected by default.
<b>Handset</b>	
<b>Handset TX Gain (dB)</b>	Configures the transmission gain of the handset.



<b>Enable EDRC Feature</b>	Enable EDRC feature, the remote party will not hear the environmental noise during a call, this option can either be set to <b>High Shielding</b> or to <b>Soft Shielding</b> .
<b>System Settings → TR-069</b>	
<b>Enable TR-069</b>	Enables TR-069
<b>ACS URL</b>	URL for TR-069 Auto Configuration Servers (ACS). Default setting is: <a href="https://acs.gdms.cloud">https://acs.gdms.cloud</a>
<b>TR-069 Username</b>	ACS username for TR-069.
<b>TR-069 Password</b>	ACS password for TR-069.
<b>Periodic Inform Enable</b>	Enables periodic inform. If set to “Yes”, device will send inform packets to the ACS. The default setting is “No”.
<b>Periodic Inform Interval</b>	Sets up the periodic inform interval to send the inform packets to the ACS. Default is 86400.
<b>Connection Request Username</b>	The username for the ACS to connect to the phone.
<b>Connection Request Password</b>	The password for the ACS to connect to the phone.
<b>Connection Request Port</b>	The port for the ACS to connect to the phone.
<b>CPE SSL Certificate</b>	The Cert File for the phone to connect to the ACS via SSL.
<b>CPE SSL Private Key</b>	The Cert Key for the phone to connect to the ACS via SSL.
<b>Start TR-069 at Random Time</b>	When enabled, TR-069 will send out first INFORM message to server on randomized timing between 1 to 3600 seconds after phone boots up.

## Maintenance Page Definitions

Table 14: Maintenance Page Definitions

<b>Maintenance → Upgrade and Provisioning</b>	
<b>Firmware</b>	
<b>Upgrade via Manually Upload</b>	
<b>Upload Firmware File to Update</b>	Upload and start upgrade firmware.
<b>Upgrade via Network</b>	
<b>Firmware Upgrade via</b>	Allows users to choose the firmware upgrade method via TFTP, HTTP or HTTPS.
<b>Firmware Server Path</b>	Defines the server path for the firmware server.





<b>Firmware Server Username</b>	The username for the firmware server.
<b>Firmware Server Password</b>	The password for the firmware server.
<b>Firmware File Prefix</b>	If configured, only the firmware with the matching encrypted prefix will be downloaded and flashed into the phone.
<b>Firmware file Postfix</b>	If configured, only the firmware with the matching encrypted postfix will be downloaded and flashed into the phone.
<b>Upgrade Detection</b>	
<b>Upgrade</b>	Press to start upgrade process.
<b>Config File</b>	
<b>Configure Manually</b>	
<b>Download Device Configuration</b>	Click to download phone's configuration file in .txt format. <b>Note:</b> Configuration file does not include passwords or CA/Custom certificate
<b>Download Device Configuration (XML)</b>	Click to download phone's configuration file in .xml format. <b>Note:</b> Configuration file does not include passwords or CA/Custom certificate
<b>Download User configuration</b>	This allows users to download part of the configuration that does not include any personal settings like Username and Passwords. Also, it will include all the changes manually made by user from web UI, or config file uploaded from "Upload Device Configuration", but not include the changes from the server provision via TFTP/FTP/FTPS/HTTP/HTTPS.
<b>Upload Device Configuration</b>	Uploads configuration file to phone.
<b>Export backup Package</b>	Export backup package which contains device configuration along with personal data.
<b>Restore from Backup package</b>	Click to upload backup package and restore.
<b>Configure via Network</b>	
<b>Config Upgrade Via</b>	Allows users to choose the config upgrade method: TFTP, FTP, FTPS, HTTP or HTTPS. The default setting is "HTTPS".
<b>Config Server Path</b>	Defines the server path for provisioning.
<b>Config Server</b>	The username for the HTTP/HTTPS server.



<b>Username</b>	
<b>Config Server Password</b>	The password for the HTTP/HTTPS server.
<b>Always Authenticate Before Challenge</b>	Only applies to HTTP/HTTPS. If enabled, the phone will send credentials before being challenged by the server.
<b>Config File Prefix</b>	Enables your ITSP to lock configuration updates. If configured, only the configuration file with the matching encrypted prefix will be downloaded and flashed into the phone.
<b>Config File Postfix</b>	Enables your ITSP to lock configuration updates. If configured, only the configuration file with the matching encrypted postfix will be downloaded and flashed into the phone.
<b>Authenticate Conf File</b>	Authenticates configuration file before acceptance.
<b>XML Config File Password</b>	The password for encrypting XML configuration file using OpenSSL. This is required for the phone to decrypt the encrypted XML configuration file.
<b>Provision</b>	
<b>Auto Upgrade</b>	
<b>Automatic Upgrade</b>	Enables automatic upgrade and provisioning. The default setting is "No".
<b>Automatic Upgrade Check Interval (m)</b>	Specifies the time period to check for firmware upgrade (in minutes). The default value is 10080.
<b>Hour of the Day(0-23)</b>	Defines the hour of the day to check the HTTP/TFTP/FTP server for firmware Upgrade or configuration files changes. The default value is 1.
<b>Day of the Week(0-6)</b>	Defines the day of the week to check HTTP/TFTP/FTP server for firmware Upgrade or configuration files changes. The default value is 1.
<b>Randomized Automatic Upgrade</b>	Randomized Automatic Upgrade within the range of hours of the day or Post pone the upgrade every X minute(s) by random 1 to X minute(s). The default setting is "No"
<b>Firmware Upgrade and Provisioning</b>	Specifies how firmware upgrading and provisioning request to be sent: Always Check for New Firmware, Check New Firmware only when F/W pre/suffix Changes, Always Skip the Firmware Check. The default setting is "Always Check for New Firmware".
<b>Firmware Upgrade Confirmation</b>	If set to "Yes", the phone will ask the user to upgrade. If there is no response, The phone will proceed with the upgrade. If set to "No", the phone will automatically upgrade without user input.



	Default is Yes.
<b>DHCP Option</b>	
<b>Allow DHCP Option 43 and Option 66 Override Server</b>	DHCP option 66 originally was only designed for TFTP server. Later, it was extended to support an HTTP URL. GRP phones support both TFTP and HTTP server via option 66. Users can also use DHCP option 43 vendor specific option to do this. DHCP option 43 approach has priorities. The phone is allowed to fall back to the original server path configured in case the server from option 66 fails. The default setting is “Yes”.
<b>Allow DHCP Option 120 to override SIP Server</b>	Enables DHCP Option 120 from local server to override the SIP Server on the phone. The default setting is “No”
<b>Additional Override DHCP Option</b>	When enabled, users could select Option 150 or Option 160 to override the Firmware server instead of using the configured firmware server path or the server from option 43 and option 66 in the local network. Please note this option will be effective only when option “Allow DHCP Option 43 and Option 66 to Override Server” is enabled. The default setting is “None”.
<b>Config Provision</b>	
<b>Download and Process ALL Available Config Files</b>	By default, device will provision the first available config in the order of cfgMAC, cfgMAC.xml, cfgMODEL.xml, cfg.xml and devMAC.cfg (corresponding to device specific, model specific, and global configs). If set to Yes, device will download and apply (overwrite) all available configs in the same order.
<b>User Protection</b>	When user protection is on, pvalues that user sets will not be changed by provision or provider.
<b>3CX Auto Provision</b>	Phone will multicast SUBSCRIBE for provision if this feature is enabled.
<b>Advanced Settings</b>	
<b>Validate Hostname in Certificate</b>	To validate the hostname in the SSL certificate
<b>Enable SIP Notify Authentication</b>	Device will challenge NOTIFY with 401 when set to Yes
<b>Factory reset</b>	Press Start to begin Factory Reset of the phone.
<b>Maintenance → System Diagnosis</b>	
<b>Syslog</b>	
<b>Syslog Protocol</b>	If set to SSL/TLS, the syslog messages will be sent through secured TLS protocol to syslog server.



	<p>Default setting is “UDP”.</p> <p><b>Note:</b> The CA certificate is required to connect with the TLS server.</p>
<b>Syslog Server</b>	<p>The URL or IP address of the syslog server for the phone to send syslog to.</p> <p><b>Note:</b> By adding port number to the Syslog server field (i.e., 172.18.1.1:1000), the phone will send syslog to the corresponding port of that IP.</p>
<b>Syslog Level</b>	<p>Selects the level of logging for syslog.</p> <p>The default setting is “None”. There are 4 levels: DEBUG, INFO, WARNING and ERROR.</p> <p>Syslog messages are sent based on the following events:</p> <ul style="list-style-type: none"> <li>• Product model/version on boot up (INFO level).</li> <li>• NAT related info (INFO level).</li> <li>• sent or received SIP message (DEBUG level).</li> <li>• SIP message summary (INFO level).</li> <li>• inbound and outbound calls (INFO level).</li> <li>• registration status change (INFO level).</li> <li>• negotiated codec (INFO level).</li> <li>• Ethernet link up (INFO level).</li> <li>• SLIC chip exception (WARNING and ERROR levels).</li> <li>• Memory exception (ERROR level).</li> </ul>
<b>Syslog Keyword Filter</b>	<p>Syslog will be filtered based on keywords provided. If you enter multiple keywords, it should be separated by ‘,’. Please note that no spaces are allowed.</p>
<b>Send SIP Log</b>	<p>Configures whether the SIP log will be included in the syslog messages. The default setting is “No”.</p> <p><b>Note:</b> By setting Send SIP Log to Yes, the phone will still send SIP log from syslog even when Syslog Level set to NONE.</p>
<b>Packet Capture</b>	
<b>With RTP Packets</b>	<p>Defines whether the packet capture file contains RTP or not. The default setting is “No”.</p>
<b>Ping</b>	
<b>Ping</b>	<p>Enter Ping target’s IP address or URL and click on start.</p>
<b>Traceroute</b>	
<b>Traceroute</b>	<p>Input target’s IP address or URL and click on start</p>
<b>Maintenance → Outbound Notification</b>	
<b>Action URL</b>	



Phone status	
<b>Setup Completed</b>	Configures the Action URL to send when phone finishes setup process.
<b>Registered</b>	Configures the Action URL to send when phone successfully registers a SIP account.
<b>Unregistered</b>	Configures the Action URL to send when phone unregisters a SIP account.
<b>Register Failed</b>	Configures the Action URL to send when phone fails to register a SIP account.
<b>Idle to Busy</b>	Configures the Action URL to send when phone's state changes from idle to busy.
<b>Busy to Idle</b>	Configures the Action URL to send when phone's state changes from busy to idle.
<b>Auto Provision Completed</b>	Configures the Action URL to send when phone's auto provisioning process is completed.
<b>IP Change</b>	Configures the Action URL to send when the IP address changes.
Phone status	
<b>Off-hook</b>	Configures the Action URL to send when phone is in off-hook state.
<b>On-hook</b>	Configures the Action URL to send when phone is in on-hook state.
<b>Incoming Calls</b>	Configures the Action URL to send when phone receives an incoming call.
<b>Outgoing Calls</b>	Configures the Action URL to send when phone places a call.
<b>Missed Call</b>	Configures the Action URL to send when phone has a missed call.
<b>Established Call</b>	Configures the Action URL to send when phone establishes a call.
<b>Forwarded Call</b>	Configures the Action URL to send when phone forwards an incoming call.
<b>Terminated Call</b>	Configures the Action URL to send when phone terminates a call.
<b>Answered Call</b>	Configures the Action URL to send when phone answers an incoming call.
<b>Rejected Call</b>	Configures the Action URL to send when phone Reject a call.
<b>Blind transfer</b>	Configures the Action URL to send when phone start a Blind Transfer.
<b>Attended Transfer</b>	Configures the Action URL to send when phone start an attended transfer
<b>Transfer Completed</b>	Configures the Action URL to send when phone complete a transfer.
<b>Transfer Failed</b>	Configures the Action URL to send when phone fail a transfer.
<b>Hold Call</b>	Configures the Action URL to send when phone hold a call.
<b>Unhold Call</b>	Configures the Action URL to send when phone unhold a call.
<b>Mute Call</b>	Configures the Action URL to send when phone mute a call.
<b>Unmute Call</b>	Configures the Action URL to send when phone unmute a call.
<b>Enable DND</b>	Configures the Action URL to send when phone enables DND.



<b>Disable DND</b>	Configures the Action URL to send when phone disables DND.
<b>Enable Call Forward</b>	Configures the Action URL to send when phone enables Call Forward.
<b>Disable Call Forward</b>	Configures the Action URL to send when phone disables call forward.
<b>Open Forward Always</b>	Configures the Action URL to send when phone enables call forward always function..
<b>Close Forward Always</b>	Configures the Action URL to send when phone disables call forward always function..
<b>Open call forward busy</b>	Configures the Action URL to send when phone enables call forward busy function..
<b>Close Call forward Busy</b>	Configures the Action URL to send when phone disables call forward busy function.
<b>Open Call Forward No Answer</b>	Configures the Action URL to send when phone enables call forward no answer function.
<b>Close Call Forward No Answer</b>	Configures the Action URL to send when phone disables call forward no answer function.
<b>Destination</b>	
<b>Add Destination</b>	
<b>Destination Name</b>	Identify the destination name. It must be unique.
<b>Protocol</b>	Configure the protocol associated with the destination server. Currently XMPP and SMTP are supported.
<b>Enable SSL</b>	Configure whether to use SSL to encrypt for SMTP protocol. This option is not editable for XMPP.
<b>Destination Address</b>	Configure destination server address, e.g., talk.google.com.
<b>Port</b>	Configure destination server port, e.g., 5222.
<b>Domain</b>	Configure the destination server domain for XMPP protocol. This option is not editable for SMTP.
<b>Username</b>	Configure the authorization username of the destination server.
<b>Password</b>	Configure the authorization user password for the destination server.
<b>From</b>	Configure the sender name for SMTP protocol. This option is not editable for XMPP.
<b>To</b>	Configure the receiver's address.
<b>Extra Attribute Name</b>	Configure extra attribute's name reserved for protocol specific attributes such as "jid" for XMPP protocol. If "jid" is specified, username and domain will be overridden.
<b>Extra Attribute Value</b>	Configure extra attribute's value reserved for protocol specific attributes such



	as "abc@gmail.com" for "jid" of XMPP protocol. If it is specified, username and domain will be overridden.
<b>Notification</b>	
<b>Add Notification</b>	
<b>Event</b>	Configures the event, which will trigger an outbound notification.
<b>Destination</b>	Configures the name of the destination where the outbound notification will be sent to.
<b>Subject</b>	Configures the subject of Email notification. This option is only applicable to SMTP protocol and it is not editable for other protocols.
<b>Message</b>	Configures the message body or the outbound notification.
<b>Extra Attribute Name</b>	Configure extra attribute's name reserved for specific attributes for a given notification in the future.
<b>Extra Attribute Value</b>	Configures extra attribute's value reserved for specific attributes for a given notification in the future.
<b>Maintenance → Voice Monitoring</b>	
<b>Session Report</b>	
<b>VQ RTCP-XR Session Report</b>	When enabled, phone will send a session quality report to the central report collector at the end of each call.
<b>Interval Report</b>	
<b>VQ RTCP-XR Interval Report</b>	When enabled, phone will send an interval quality report to the central report collector periodically throughout a call.
<b>VQ RTCP-XR Interval Report Period</b>	Configure the interval (in seconds) of phone sending an interval quality report to the central report collector periodically throughout a call.
<b>Alert Report</b>	
<b>Warning Threshold for Moslq</b>	Configure the threshold value of listening MOS score (MOS-LQ) multiplied by 10. The threshold value of MOS-LQ causes the phone to send a warning alert quality report to the central report collector.
<b>Critical Threshold for Moslq</b>	Configure the threshold value of listening MOS score (MOS-LQ) multiplied by 10. The threshold value of MOS-LQ causes the phone to send a critical alert quality report to the central report collector.
<b>Warning Threshold for Delay</b>	Configure the threshold value of one way delay (in milliseconds) that causes the phone to send a warning alert quality report to the central report collector.
<b>Critical Threshold for Delay</b>	Configure the threshold value of one way delay (in milliseconds) that causes the phone to send a critical alert quality report to the central report collector.
<b>Display Report</b>	



<b>Display Report on Web UI</b>	When enabled, the phone will display the quality report on the Web GUI.
<b>Display Report on LCD</b>	When enabled, phone will display the quality report on LCD.
<b>Custom Display Layout on LCD</b>	Custom report layout displayed on LCD.
<b>Scheduled Tasks</b>	
<b>Working Time</b>	When enabled, the phone will display the quality report on the Web GUI.
<b>Add Scheduled Tasks</b>	
<b>Scheduled Tasks Type</b>	Select the type of scheduled task.
<b>Target</b>	Configures the extension for the call to be forwarded to.
<b>Account</b>	Select the local account to be transferred regularly.
<b>Repetition Period</b>	Configures the recurring day of the scheduled task.
<b>Effective Time</b>	Effective Time: <b>Custom, Working time, non-working time</b>

## Application Page Definitions

Table 15: Application Page Definitions

<b>Application → Web Service</b>		
<b>Use Auto Location Service</b>		To enable or disable auto location services on the phone. (Reboot Required)
<b>Application → XML Application</b>		
<b>Idle Screen</b>		
<b>Idle Screen XML Download</b>		Configures to enable idle screen XML download via HTTP, HTTPS or TFTP.
<b>Download Screen XML at Boot-up</b>		If set to "Yes", the idle screen XML file will be downloaded when the phone boots up.
<b>Use Custom Filename</b>		Specifies the custom file name for XML idle screen downloaded.
<b>Idle Screen XML Server Path</b>		Specifies the custom file name for XML idle screen downloaded.
<b>XML File Example</b>		Click to download an example XML file based on which you can make custom changes. Note: in the XML file users can set up multiple custom screens n the same file.
<b>Application → Contacts</b>		





<b>Contacts</b>	
<b>Add Contact</b>	Press Add to create a new contact.
<b>Edit</b>	Edits the contact parameters.
<b>Delete All Contacts</b>	Press to delete all contacts.
<b>Group Management</b>	
<b>Add Group</b>	Specifies Group's name to add new group. More than 30 Groups supported.
<b>Edit Group</b>	Edits selected group.
<b>Delete Group</b>	Delete Selected group
<b>Phonebook Management</b>	
<b>Enable Phonebook XML Download</b>	Configures to enable phonebook XML download. Users could select HTTP/HTTPS/TFTP to download the phonebook file. The default setting is "Disabled".
<b>HTTP/HTTPS Username</b>	The username for the HTTP/HTTPS server.
<b>HTTP/HTTPS Password</b>	The password for the HTTP/HTTPS server.
<b>Phonebook XML Server Path</b>	Configures the server path to download the phonebook XML. This field could be IP address or URL, with up to 256 characters.
<b>Phonebook Download Interval</b>	Configures the phonebook download interval (in minutes). If set to 0, automatic download will be disabled. The default value is 0. Valid range is 5 to 720 minutes.
<b>Remove Manually-edited Entries on Download</b>	If set to "Yes", when XML phonebook is downloaded, the entries added manually will be automatically removed. The default setting is "Yes".
<b>Import Group Method</b>	<ul style="list-style-type: none"> <li>When set to "<b>Replace</b>", existing groups will be completely replaced by imported one.</li> <li>When set to "<b>Append</b>", the imported groups will be attended with the current one.</li> </ul> The default setting is "Replace".
<b>Sort Phonebook by</b>	Sort phonebook based on the selection of first name or last name. The default setting is "Last Name".
<b>Download XML Phonebook</b>	Click on "Download" to download the XML phonebook file to local PC
<b>Upload XML Phonebook</b>	Click on "Upload" to upload local XML phonebook file to the phone.



<b>Default Search Mode</b>	Configure the default phone book search mode.
<b>Application → LDAP</b>	
<b>Obtain from UCM Server</b>	
<b>Obtain From UCM server</b>	Obtain LDAP Configuration File
<b>Manual Import</b>	
<b>Manual Import</b>	Users can import an LDAP configuration file, and can also download an example file.
<b>Local Configuration</b>	
<b>LDAP Protocol</b>	Configures the LDAP protocol to LDAP or LDAPS. The default setting is "LDAP". LDAPS is a feature to support LDAP over TLS.
<b>Server Address</b>	Configures the IP address or DNS name of the LDAP server.
<b>Port</b>	Configures the LDAP server port. The default port number is "389".
<b>Base DN</b>	Configures the LDAP search base. This is the location in the directory where the search is requested to begin. <u>Example:</u> dc=grandstream, dc=com ou=Boston, dc=grandstream, dc=com
<b>Username</b>	Configures the bind "Username" for querying LDAP servers. Some LDAP servers allow anonymous binds in which case the setting can be left blank.
<b>Password</b>	Configures the bind "Password" for querying LDAP servers. The field can be left blank if the LDAP server allows anonymous binds.
<b>LDAP Number Filter</b>	Configures the filter used for number lookups. <u>Examples:</u> ((telephoneNumber=%)(Mobile=%)) returns all records which has the "telephoneNumber" or "Mobile" field starting with the entered prefix; (&(telephoneNumber=%) (cn=*)) returns all the records with the "telephoneNumber" field starting with the entered prefix and "cn" field set.
<b>LDAP Name Filter</b>	Configures the filter used for name lookups. <u>Examples:</u> ((cn=%)(sn=%)) returns all records which has the "cn" or "sn" field starting with the entered prefix; (!(sn=%)) returns all the records which do not have the "sn" field starting with the entered prefix; (&(cn=%) (telephoneNumber=*)) returns all the records with the "cn" field starting with the entered prefix and "telephoneNumber" field set.



<b>LDAP Version</b>	Selects the protocol version for the phone to send the bind requests. The default setting is "Version 3".
<b>LDAP Name Attributes</b>	Specifies the "name" attributes of each record which are returned in the LDAP search result. This field allows the users to configure multiple space separated name attributes. <u>Example:</u> gn cn sn description
<b>LDAP Number Attributes</b>	Specifies the "number" attributes of each record which are returned in the LDAP search result. This field allows the users to configure multiple space separated number attributes. <u>Example:</u> telephoneNumber telephoneNumber Mobile
<b>LDAP Display Name</b>	Configures the entry information to be shown on phone's LCD. Up to 3 fields can be displayed. <u>Example:</u> %cn %sn %telephoneNumber
<b>Max. Hits</b>	Specifies the maximum number of results to be returned by the LDAP server. If set to 0, server will return all search results. The default setting is 50.
<b>Search Timeout</b>	Specifies the interval (in seconds) for the server to process the request and client waits for server to return. The default setting is 30 seconds.
<b>Sort Results</b>	Specifies whether the searching result is sorted or not. Default setting is "No".
<b>LDAP Lookup</b>	Configures to enable LDAP number searching when dialing / receiving calls.
<b>Lookup Display Name</b>	Configures the display name when LDAP looks up the name for incoming call or outgoing call. This field must be a subset of the LDAP Name Attributes. <u>Example:</u> gn cn sn description
<b>LDAP Dialing Default Account</b>	Configures the default account used when dialing LDAP contact
<b>Exact Match Search</b>	Search for exact match result. Default setting is "No".

**Application → Remote Phonebook**



The user can configure up to 3 XML Remote Phonebooks.	
<b>Display Name</b>	Configures the entry information to be shown on phone's LCD.
<b>URL</b>	Configures the XML Phonebook URL.
<b>Username</b>	The user name for the phonebook.
<b>Password</b>	The password for the phonebook.
<b>Remote Phonebook Update Interval</b>	Configures the Remote Phonebook download Interval (in minutes). If set to 0, automatic download will be disabled. Valid range is 5 to 720.
<b>Application → Call History</b>	
<b>Delete</b>	Users can select an entry, then click “Delete” to remove it from the list.
<b>Delete All</b>	Click on Delete All to remove all Call History stored in the phone. Note: Users could use the drop-down list to show only selected call history type (All, Answered, Dialed, Missed, and Transferred) and use navigation keys to browse pages when many entries exist.

## External Service Page Definitions

Table 16: External Service Page Definitions

<b>External Service → GDS</b>	
<b>GDS</b>	<p>Connect to a GDS37XX and send OpenDoor request.</p> <ul style="list-style-type: none"> <li>• <b>Service Type</b> Select GDS as service type.</li> <li>• <b>Account</b> The account to be used on the phone to interact with the GDS37XX.</li> <li>• <b>System Identification</b> A name or a number to identify the GDS37XX.</li> <li>• <b>System Number</b> The SIP extension or the IP address of the GDS37XX depending on the deployed scenario, Peering or Registration.</li> <li>• <b>Access Password</b> The password set on the GDS37XX to unlock the door.</li> <li>• <b>System Ringtone</b> Select the system ringtone from the dropdown list to be played when there is an incoming call from the configured system number of the GDS37xx.</li> </ul> <p><b>Notes:</b></p> <ul style="list-style-type: none"> <li>- When using Peering scenario, on “System Number” field of the</li> </ul>



	<p>GRP260x specify the IP address of the peered GDS37XX.</p> <ul style="list-style-type: none"> <li>- When using Registration scenario and both GRP260x and GDS37XX are registered on the same SIP server, specify the SIP extension of the GDS37XX on “System Number” field on GXP16XX. The “Access Password” on GRP260x should be matching “Remote PIN to Open the door” on GDS37XX.</li> </ul>
--	---

**External Service → Call Center**

<b>Call Center Codes</b>	Set the disposition code and the unavailable code for quick selection on the phone side
<b>Wrap-up Countdown</b>	Configure the countdown times when the agent status is Wrap-up and execute the countdown on the LCD. If set to 0, the countdown is disabled

**External Service → Broadsoft XSI**

**Authentication Login**

<b>Server</b>	Broadsoft XSI server address with protocol.
<b>Port</b>	Port of the Broadsoft XSI server.
<b>XSI Action Path</b>	Configure the deployment path for Broadsoft XSI Actions. If it is empty, the path "com.broadsoft.xsi-actions" will be used.
<b>XSI Authentication Type</b>	Defines the authentication type to use login credentials or SIP credentials. If set to "Login Credentials", please fill in User ID and Password in the following options; If set to "SIP Credentials", please fill in user ID, Authentication ID, and Authentication Password.
<b>BroadWorks User ID</b>	SIP User ID for Broadsoft XSI server.
<b>SIP Authentication ID</b>	SIP Username for Broadsoft XSI server.
<b>SIP Authentication Password</b>	SIP Password for Broadsoft XSI server.
<b>Auto Login</b>	If set to "Yes", the device will automatically login in the background after booting up, so that the BS Xsi always remains logged in. LCD can get the latest Directories, can directly enter the BS Xsi user service, and trigger the update of data in the background.

**Service Settings**

<b>Sort Phonebook by</b>	Sort phonebook based on the selection of first name or last name.
<b>BroadSoft Directory Update Interval (m)</b>	Configures the BroadSoft phonebook download interval (in minutes). If set to 0, automatic download will be disabled. Valid range is 5 to 4320.



<b>Broadsoft Contacts Download Limitation</b>	<p>The maximum contacts that can be downloaded for each BroadSoft XSI server directory. The valid range is from 0 to 2000. If set to 0, the server's default contact limit will be used. If the total contact records returned by the server is larger than this limit then it will not be downloaded, and the device will be limited to remote search.</p>
<b>BroadSoft Contacts Search limitation</b>	<p>The maximum remote search records that can be downloaded for the BroadSoft XSI server directory. The valid range is from 0 to 2000. If set to 0, there is no limit. If the search result total records exceed this value, it will not be downloaded, and you will need to narrow the search scope.</p>
<b>Network Directories</b>	
<b>Type</b>	<p>Enable/Disable Broadsoft Network directories. The directory types are:</p> <ul style="list-style-type: none"> <li>• <b>Group Directory</b> Enable/Disable and rename the BroadWorks Xsi Group Directory features on the phone. If keep the Name box blank, the phone will use the default name "Group" for it.</li> <li>• <b>Enterprise Directory</b> Enable/Disable and rename the BroadWorks Xsi Enterprise Directory features on the phone. If keep the Name box blank, the phone will use the default name "Enterprise" for it.</li> <li>• <b>Group Common</b> Enable/Disable and rename the BroadWorks Xsi Group Common Directory features on the phone. If keep the Name box blank, the phone will use the default name "Group Common" for it.</li> <li>• <b>Enterprise Common</b> Enable/Disable and rename the BroadWorks Xsi Enterprise Common Directory features on the phone. If keep the Name box blank, the phone will use default name "Enterprise Common" for it.</li> <li>• <b>Personal Directory</b> Enable/Disable and rename the BroadWorks Xsi Personal Directory features on the phone. If keep the Name box blank, the phone will use the default name "Personal" for it.</li> <li>• <b>Missed Call Log</b> Enable/Disable and rename the BroadWorks Xsi Missed Call Log</li> </ul>



	<p>features on the phone. If keep the Name box blank, the phone will use the default name “Missed” for it.</p> <ul style="list-style-type: none"> <li> <b>Placed Call Log</b>            Enable/Disable and rename the BroadWorks Xsi Placed Call Log features on the phone. If keep the Name box blank, the phone will use the default name “Outgoing” for it         </li> <li> <b>Received Call Log</b>            Enable/Disable and rename the BroadWorks Xsi Placed Call Log features on the phone. If keep the Name box blank, the phone will use the default name “Incoming” for it.         </li> </ul>
<b>Name</b>	Defines the directory name.



## NAT SETTINGS

If the devices are kept within a private network behind a firewall, we recommend using STUN Server. The following settings are useful in the STUN Server scenario:

- **STUN Server**

Under **Settings**→**General Settings**, enter a STUN Server IP (or FQDN) that you may have, or look up a free public STUN Server on the internet and enter it on this field. If using Public IP, keep this field blank.

- **Use Random Ports**

It is under **Settings**→**General Settings**. This setting depends on your network settings. When set to "Yes", it will force random generation of both the local SIP and RTP ports. This is usually necessary when multiple GRPs are behind the same NAT. If using a Public IP address, set this parameter to "No".

- **NAT Traversal**

It is under **Accounts X**→**Network Settings**. Default setting is "No". Enable the device to use NAT traversal when it is behind firewall on a private network. Select Keep-Alive, Auto, STUN (with STUN server path configured too) or other option according to the network setting.





## PACKET CAPTURE

GRP260X is embedded with packet capture function. The related options are under **Maintenance→System Diagnosis → Packet Capture**.

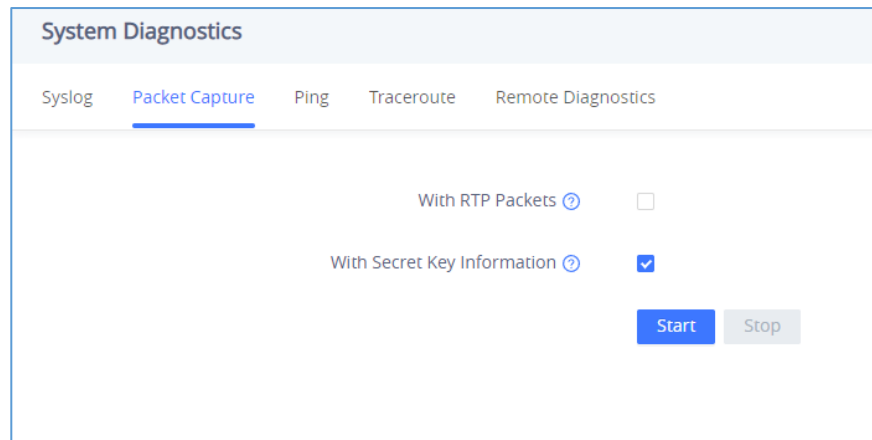
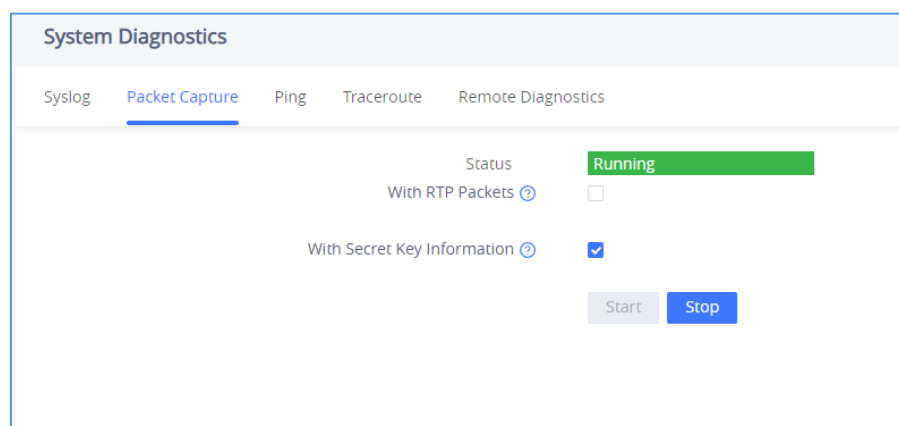

**Figure 6: Packet Capture in Idle**

User can also define whether RTP packets will be captured or not from **With RTP Packets** option.

When the capture configuration is set, press **Start** button to start packet capture. The Status will become **RUNNING** while capturing, as showed in *Figure 7: Packet Capture when running*. Press **Stop** button to end capture.

Press Download button to download capture file to local PC. The capture file is in .pcap format.



**Figure 7: Packet Capture when running**



## UPGRADING AND PROVISIONING

### Unified Firmware

The GRP2601 / GRP2601P / GRP2602 / GRP2602P / GRP2602W / GRP2603 / GRP2603P / GRP2604 / GRP2604P support unified firmware for all GRP260X models.

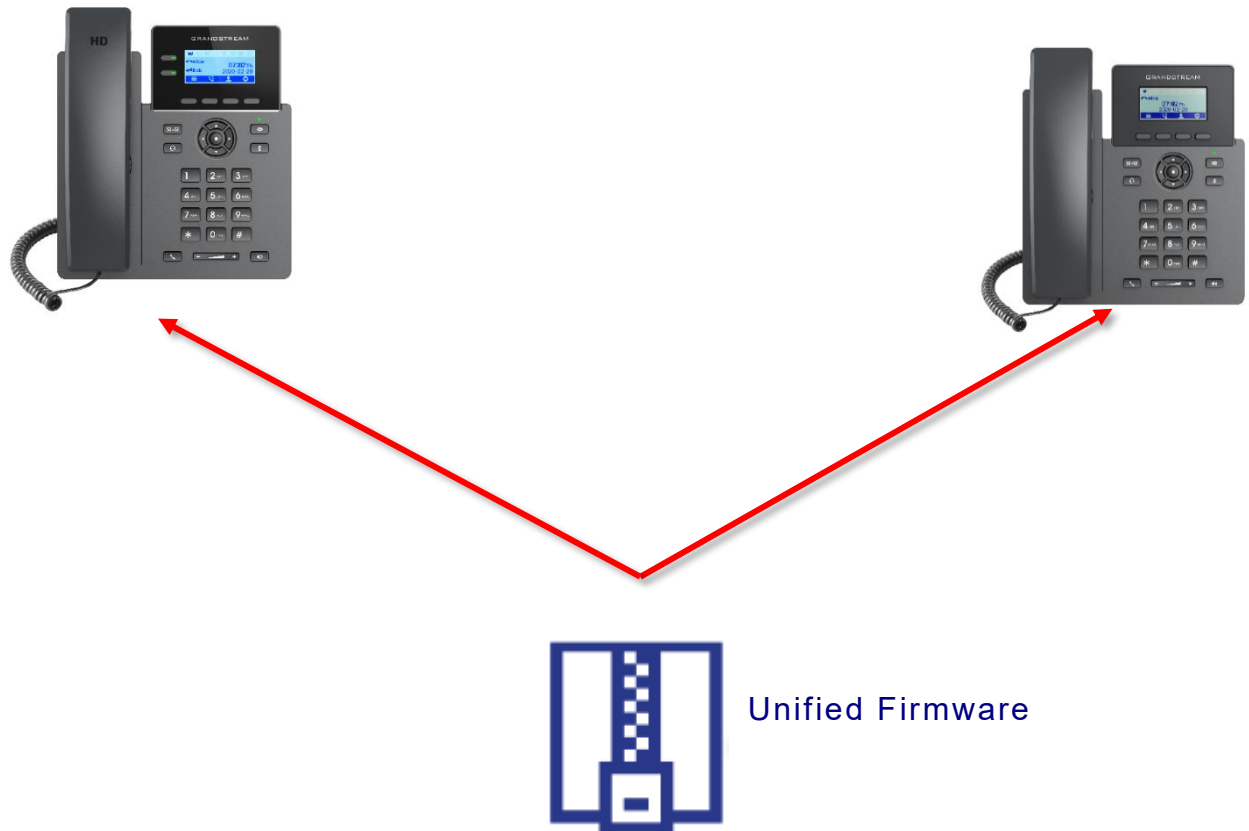

Figure 8: GRP260X Unified Firmware

### Firmware Upgrade

The GRP260X series can be upgraded via TFTP / FTP / FTPS / HTTP / HTTPS by configuring the URL/IP Address for the TFTP / HTTP / HTTPS / FTP / FTPS server and selecting a download method. Configure a valid URL for TFTP, FTP/FTPS or HTTP/HTTPS, the server name can be FQDN or IP address.

**Examples of valid URLs:**

[firmware.grandstream.com/BETA](http://firmware.grandstream.com/BETA)

[fw.mycompany.com](http://fw.mycompany.com)

**Upgrade via Web GUI**

Open a web browser on PC and enter the IP address of the phone. Then, login with the administrator username and password. Go to Maintenance→Upgrade and Provisioning page, enter the IP address or the FQDN for the upgrade server in "Firmware Server Path" field and choose to upgrade via TFTP or HTTP/HTTPS or FTP/FTPS. Update the change by clicking the "Save and apply" button. Then "Reboot" or power cycle the phone to update the new firmware.

When upgrading starts, the screen will show upgrading progress. When done you will see the phone restart again. Please do not interrupt or power cycle the phone when the upgrading process is on.

Firmware upgrading takes around 60 seconds in a controlled LAN or 5-10 minutes over the Internet. We recommend completing firmware upgrades in a controlled LAN environment whenever possible.

**No Local TFTP/FTP/HTTP Servers**

For users that would like to use remote upgrading without a local TFTP/FTP/HTTP server, Grandstream offers a NAT-friendly HTTP server. This enables users to download the latest software upgrades for their phone via this server. Please refer to the webpage:

<https://www.grandstream.com/support/firmware>

Alternatively, users can download a free TFTP, FTP or HTTP server and conduct a local firmware upgrade. A free window version TFTP server is available for download from:

[http://www.solarwinds.com/products/freetools/free\\_tftp\\_server.aspx](http://www.solarwinds.com/products/freetools/free_tftp_server.aspx)

<http://tftpd32.jounin.net/>.

Instructions for local firmware upgrade via TFTP:

1. Unzip the firmware files and put all of them in the root directory of the TFTP server.
2. Connect the PC running the TFTP server and the phone to the same LAN segment.
3. Launch the TFTP server and go to the File menu→Configure→Security to change the TFTP server's default setting from "Receive Only" to "Transmit Only" for the firmware upgrade.
4. Start the TFTP server and configure the TFTP server in the phone's web configuration interface.
5. Configure the Firmware Server Path to the IP address of the PC.



6. Update the changes and reboot the phone.

End users can also choose to download a free HTTP server from <http://httpd.apache.org/> or use Microsoft IIS web server.

## Custom Ringtones Provisioning

The custom ringtones can be provisioned from the link configured under the firmware server path, up to 6 ringtones can be customized. The phone will be looking for ringx.ogg as shown below, where x can be from 1 to 6:

```
155 GRP2603P [c0:74:ad:27:76:65]: PROVN INFO [1.0.1.36] Ring upgrade from URL http://fm.grandstream.com/gs/ring1.ogg\n145 GRP2603P [c0:74:ad:27:76:65]: PROVN INFO [1.0.1.36] Downloading http://fm.grandstream.com/gs/ring1.ogg\n
```

Figure 9: Custom ringtone provisioning

**Note:** Users can use the link <https://convertio.co/wav-ogg/> in order to generate the .ogg file but kindly make sure of the below settings before converting the .wave file to .ogg file:

- Codec: must be Opus
- Frequency: 16K
- Audio Channel: Mono

## Phone Provisioning

### Configuration File Download

Grandstream SIP Devices can be configured via the Web Interface as well as via a Configuration File (binary or XML) through TFTP, FTP/FTPS or HTTP/HTTPS. The "Config Server Path" is the TFTP, FTP/FTPS or HTTP/HTTPS server path for the configuration file. It needs to be set to a valid URL, either in FQDN or IP address format. The "Config Server Path" can be the same or different from the "Firmware Server Path".

A configuration parameter is associated with each field in the web configuration page. A parameter consists of a Capital letter P and 2 to 5-digit numeric numbers. i.e., P2 is associated with the "New Password" in the Web GUI → **System Settings** → **Security Settings** → **User Info Management** → **Admin Password**. For a detailed parameter list, please refer to the corresponding configuration template.

When the GRP260x series boots up or reboots, it will issue a request to download an XML file named "cfgxxxxxxxxxxxx.xml", where "xxxxxxxxxxxx" is the MAC address of the phone, i.e., "cfg000b820102ab" and "cfg000b820102ab.xml". If the download of "cfgxxxxxxxxxxxx.xml" file is not successful followed by a configuration file named "cfgxxxxxxxxxxxx", the phone will issue a request to download a specific model configuration file "cfg<model>.xml", where <model> is the phone model, i.e., "cfggrp2601.xml" for the GRP2601, "cfggrp2602" for the GRP2602, "cfggrp2603" for the GRP2603 and "cfggrp2604" for the GRP2604.



If this file is not available, the phone will issue a request to download the generic “cfg.xml” file. The configuration file name should be in lower case letters, If not found, the phone will request a file named “dev[MacAddress].cfg” where “MacAddress” is the MAC address of the device, With this provision file, users are able to provision the device with both Pvalues and aliases.

```
download http://fm.grandstream.com/gs/cfgc074ad224d4a.xml (No error)\n
download http://fm.grandstream.com/gs/cfgc074ad224d4a (No error)\n
download http://fm.grandstream.com/gs/cfggrp2601.xml (No error)\n
download http://fm.grandstream.com/gs/cfg.xml (No error)\n
download http://fm.grandstream.com/gs/devc074ad224d4a.cfg (No error)\n
download https://fm.grandstream.com/gs/cfgc074ad224d4a.xml (No error)\n
download https://fm.grandstream.com/gs/cfgc074ad224d4a (No error)\n
download https://fm.grandstream.com/gs/cfggrp2601.xml (No error)\n
download https://fm.grandstream.com/gs/cfg.xml (No error)\n
download https://fm.grandstream.com/gs/devc074ad224d4a.cfg (No error)\n
```

**Figure 10: Config File Download**

**Note: (Attempt to download Config File again)**

When doing provision on the phone, if your first config file contains p-values listed below, phone will try to download the potential second cfg.xml file and apply the second file without rebooting. Maximum 3 extra attempts.

Those P-values are:

- \*212 -- Config upgrade via
- \*234 -- Config prefix
- \*235 -- Config postfix
- \*237 -- Config upgrade Server
- \*240 – Authenticate Config File
- \*1359 – XML Config File Password
- \*8463 – Validate Server Certificate
- \*8467 – Download and process ALL Available Config Files
- \*20713 – Always authenticate before challenge
- \*22011 – Bypass Proxy For
- \*22030 – Enable SSL host verification for provision

**Note: (P-values that trigger Auto-Provision)**



If the p-values listed below are changed while managing configuration on web UI or LCD, the provision process will be triggered:

- \* 192 -- Firmware upgrade server
- \* 232 -- Firmware prefix
- \* 233 -- Firmware postfix
- \* 6767 -- Firmware Upgrade Via
- \* 6768 -- Firmware HTTP/HTTPS Username
- \* 6769 -- Firmware HTTP/HTTPS Password
- \* 237 -- Config upgrade Server
- \* 212 -- Config upgrade via
- \* 234 -- Config prefix
- \* 235 -- Config postfix
- \* 1360 -- Config HTTP/HTTPS username
- \* 1361 -- Config HTTP/HTTPS password.

**Note: P-Value that forces reboot when changes are applied by downloading the config file**

When P-value 22421 (or alias “provision.config.forceReboot”) set to 1 in config file, phone will need to reboot if any change is applied by downloading the config file. Specifically following the process below:

- First time download:
  1. Phone downloaded a config file (in any supported format) with P22421 set to 1 included.
  2. Phone found there is change(s) comparing with current setting on the phone (Any valid P-value change, no matter if it does need reboot to apply or not).
  3. Phone will update to new setting (will not save P22421 itself) and will go into normal reboot process (e.g.: if there is active call, phone will wait until it is finished)
- Second time download:
  4. After reboot, phone may download the same config file again (if the config file path did not change).
  5. Phone checked the config file and found there is no Pvalue needed to be updated.
  6. Phone will not reboot again.

**Note: Certificates and Keys provisioning**



Users can configure the phone to get all the needed certificates during boot up. Instead of putting the certificate/key content in text directly from the Web interface or uploading them manually, they can choose to provision them from the configuration file by putting the URL in the Pvalue field of each certificate and/or key. (e.g., [http://ProvisionServer\\_address/SIP-TLS-Certificate.pem](http://ProvisionServer_address/SIP-TLS-Certificate.pem)) The phone will then process the URL, search for the appropriate certificate/Key file, download it and then apply it into the phone.

```
HTTP GET /SIP-TLS-Private-Key.key HTTP/1.1
HTTP HTTP/1.1 200 OK (application/octet-stream)
HTTP GET /SIP-TLS-Certificate.pem HTTP/1.1
HTTP HTTP/1.1 200 OK (application/octet-stream)
HTTP GET /Trusted-certificate-1.crt HTTP/1.1
HTTP HTTP/1.1 200 OK (application/octet-stream)
HTTP GET /Trusted-certificate-2.crt HTTP/1.1
HTTP HTTP/1.1 200 OK (application/octet-stream)
HTTP GET /Trusted-certificate-3.crt HTTP/1.1
HTTP HTTP/1.1 200 OK (application/octet-stream)
HTTP GET /Trusted-certificate-4.crt HTTP/1.1
HTTP HTTP/1.1 200 OK (application/octet-stream)
HTTP GET /Trusted-certificate-5.crt HTTP/1.1
HTTP HTTP/1.1 200 OK (application/octet-stream)
HTTP GET /Trusted-certificate-6.crt HTTP/1.1
HTTP HTTP/1.1 200 OK (application/octet-stream)
HTTP GET /OpenVPN-CA.crt HTTP/1.1
HTTP HTTP/1.1 200 OK (application/octet-stream)
HTTP GET /OpenVPN-Certificate.pem HTTP/1.1
HTTP HTTP/1.1 200 OK (application/octet-stream)
HTTP GET /OpenVPN-Key.key HTTP/1.1
HTTP HTTP/1.1 200 OK (application/octet-stream)
```

**Figure 11: Certificates Files Download**

For more details on XML provisioning, please refer to:

[https://www.grandstream.com/sites/default/files/Resources/gs\\_provisioning\\_guide.pdf](https://www.grandstream.com/sites/default/files/Resources/gs_provisioning_guide.pdf)

## No Touch Provisioning

After the phone sends, config file request to the Broadsoft provisioning server via HTTP/HTTPS, if the provisioning server responds “401 Unauthorized” asking for authentication, the phone’s LCD will prompt a window for user to enter username and password. Once correct username and password are entered, the phone will send config file request again with authentication. Then the phone will receive the config file to download and get provisioned automatically.

Besides manually entering the username and password in LCD prompt, users can save the login credentials for provisioning process as well. The username and password configuration are under phone’s web UI→**Maintenance**→**Upgrade and provisioning** page: “HTTP/HTTPS Username” and “HTTP/HTTPS Password”. If the saved username and password saved are correct, login window will be skipped. Otherwise, login window will be popped up to prompt users to enter correct username and password again.



## RESTORE FACTORY DEFAULT SETTINGS

---

### **Warning:**

Restoring the Factory Default Settings will delete all configuration information on the phone. Please backup or print all the settings before you restore to the factory default settings. Grandstream is not responsible for restoring lost parameters and cannot connect your device to your VoIP service provider.

---

### Restore Factory Settings using LCD menu

Please follow the instructions below to reset the phone:

1. Press MENU button to bring up the keypad configuration menu.
2. Navigate to Settings → Advanced Settings.
3. Select "Factory Reset".
4. A warning window will pop out to make sure a reset is requested and confirmed.

Press the "Yes" Softkey to confirm and the phone will reboot, or "No" Softkey to cancel the Reset.

### Restore to Factory Default via Web GUI

1. Login GRP2601/GRP2602/GRP2603/GRP2604 Web GUI.
2. Navigate to Maintenance → Upgrade and provisioning → Advanced Settings → Factory reset.
3. Press on **Start** Button situated against Factory reset option

Click "OK" to confirm and the phone will reboot, or on "Cancel" to cancel the Reset.

### Restore to Factory Default via Keypad

1. The phone is in idle state
2. Press and hold Softkey1 and Down button Until a factory reset confirmation message is displayed
3. Or dial call feature code **\*\*02030203\*\*** to initiate a factory reset.





## EXPERIENCING GRP260X

Please visit our website: <https://www.grandstream.com> to receive the most up- to-date updates on firmware releases, additional features, FAQs, documentation, and news on new products.

We encourage you to browse our [product related documentation](#), [FAQs](#) and [User and Developer Forum](#) for answers to your general questions. If you have purchased our products through a Grandstream Certified Partner or Reseller, please contact them directly for immediate support.

Our technical support staff is trained and ready to answer all your questions. Contact a technical support member or [submit a trouble ticket online](#) to receive in-depth support.

Thank you again for purchasing Grandstream IP phone, it will be sure to bring convenience and color to both your business and personal life.

